

F 012 330 200
Issue 13-04-22
Stand

Fig./Abb. 1

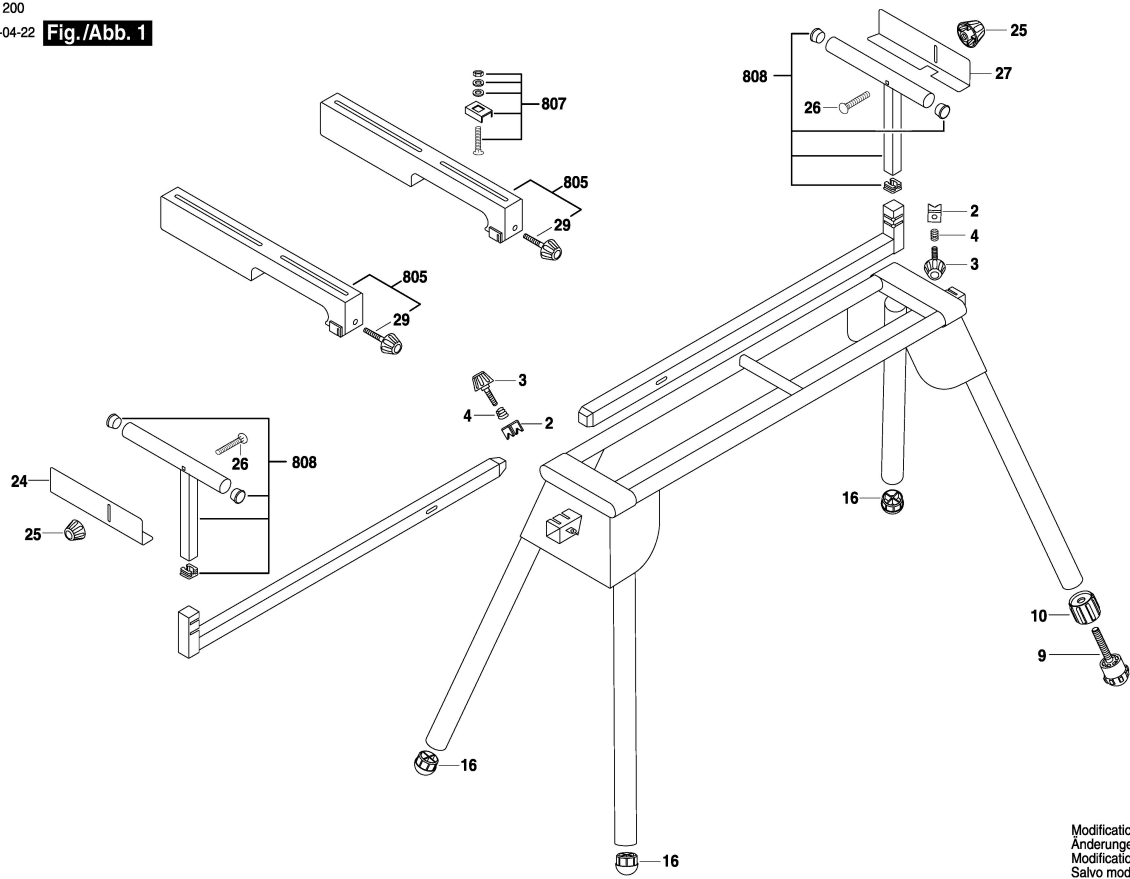

Modifications reserved
Änderungen vorbehalten
Modifications réservées
Salvo modificaciones