

F 012 331 700

Stand 13-05
Issue 14-05-20

Fig./Abb. 1

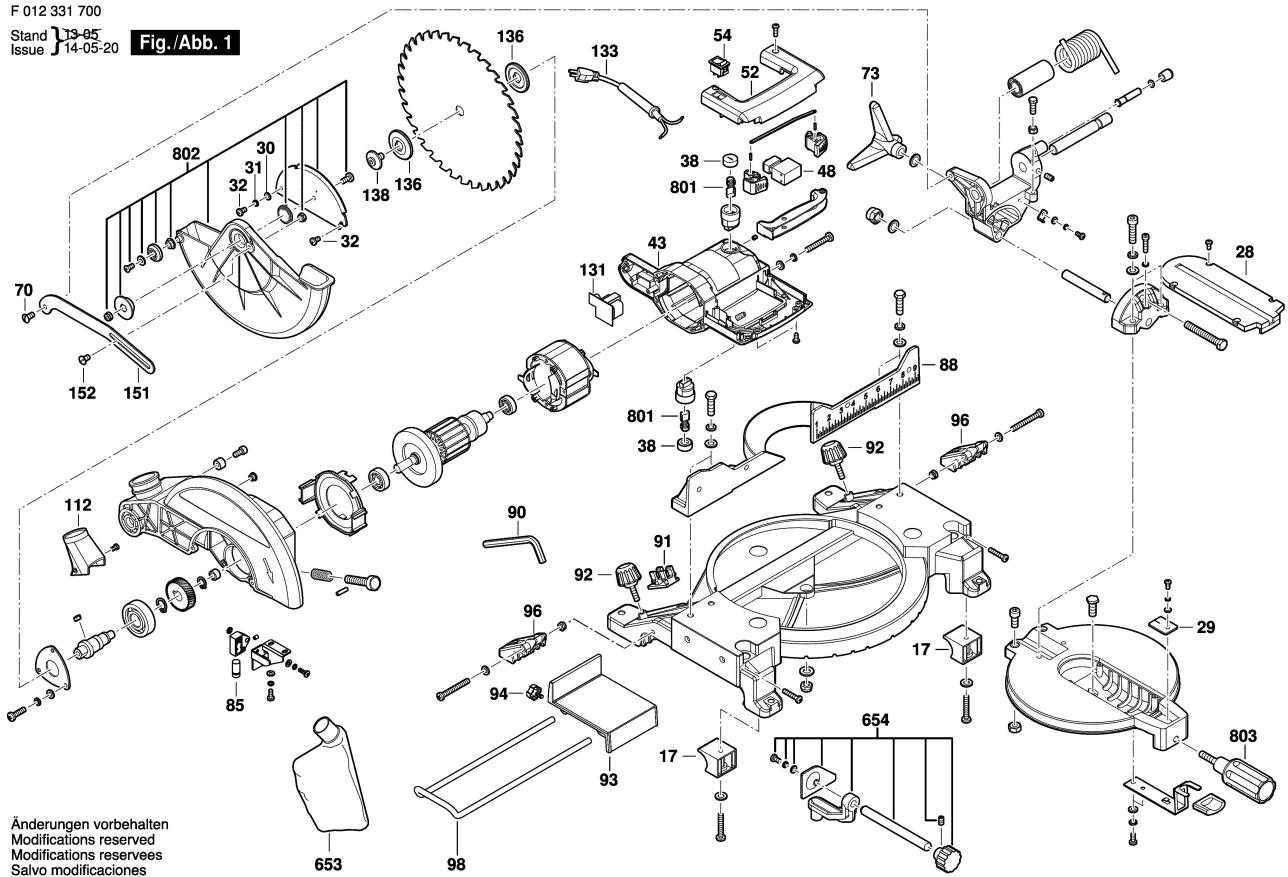

Änderungen vorbehalten
Modifications reserved
Modifications reserves
Salvo modificaciones