

F 012 333 507
Issue
Stand

11-08-23 **Fig. /Abb. 1**

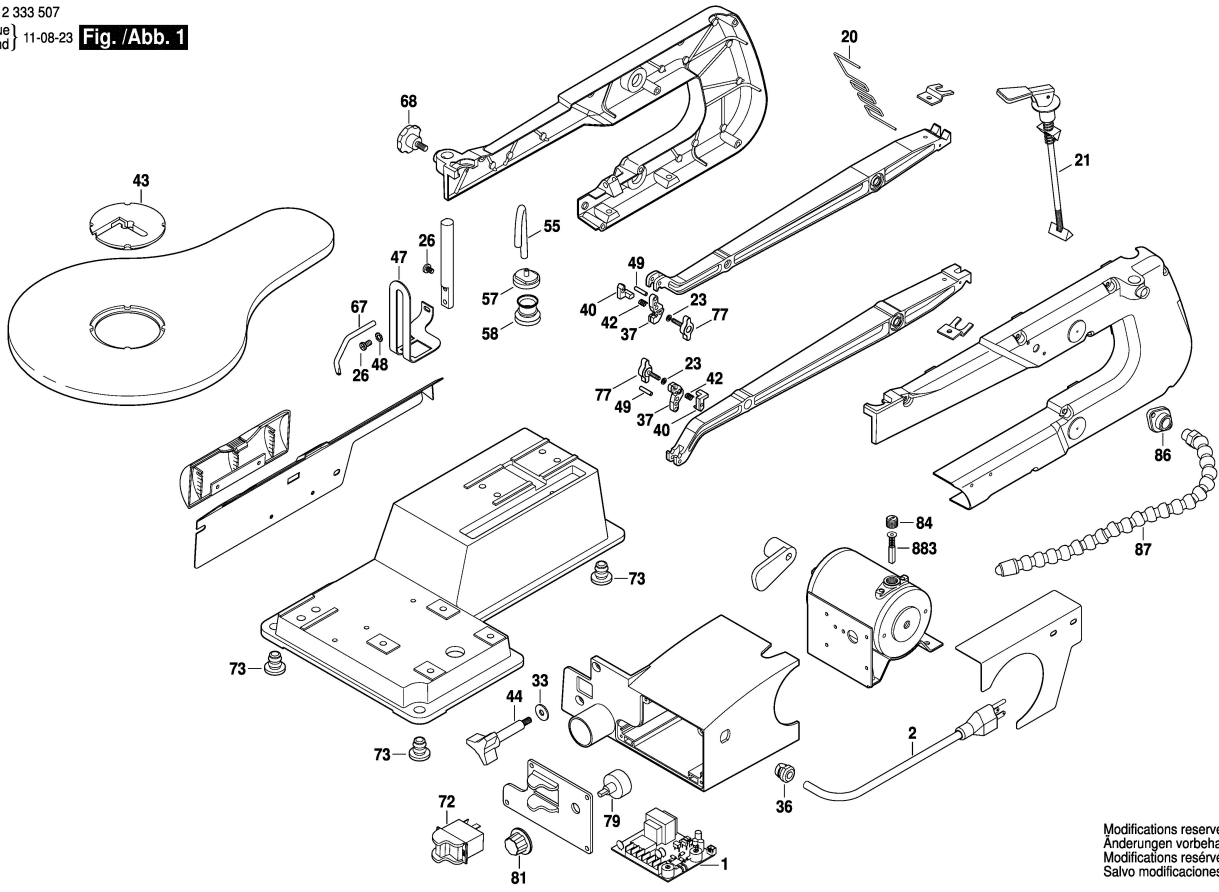

Modifications reserved
Änderungen vorbehalten
Modifications réservées
Salvo modificaciones