

F 012 338 500  
Issue  
Stand

08-09-15 **Fig. /Abb. 1**

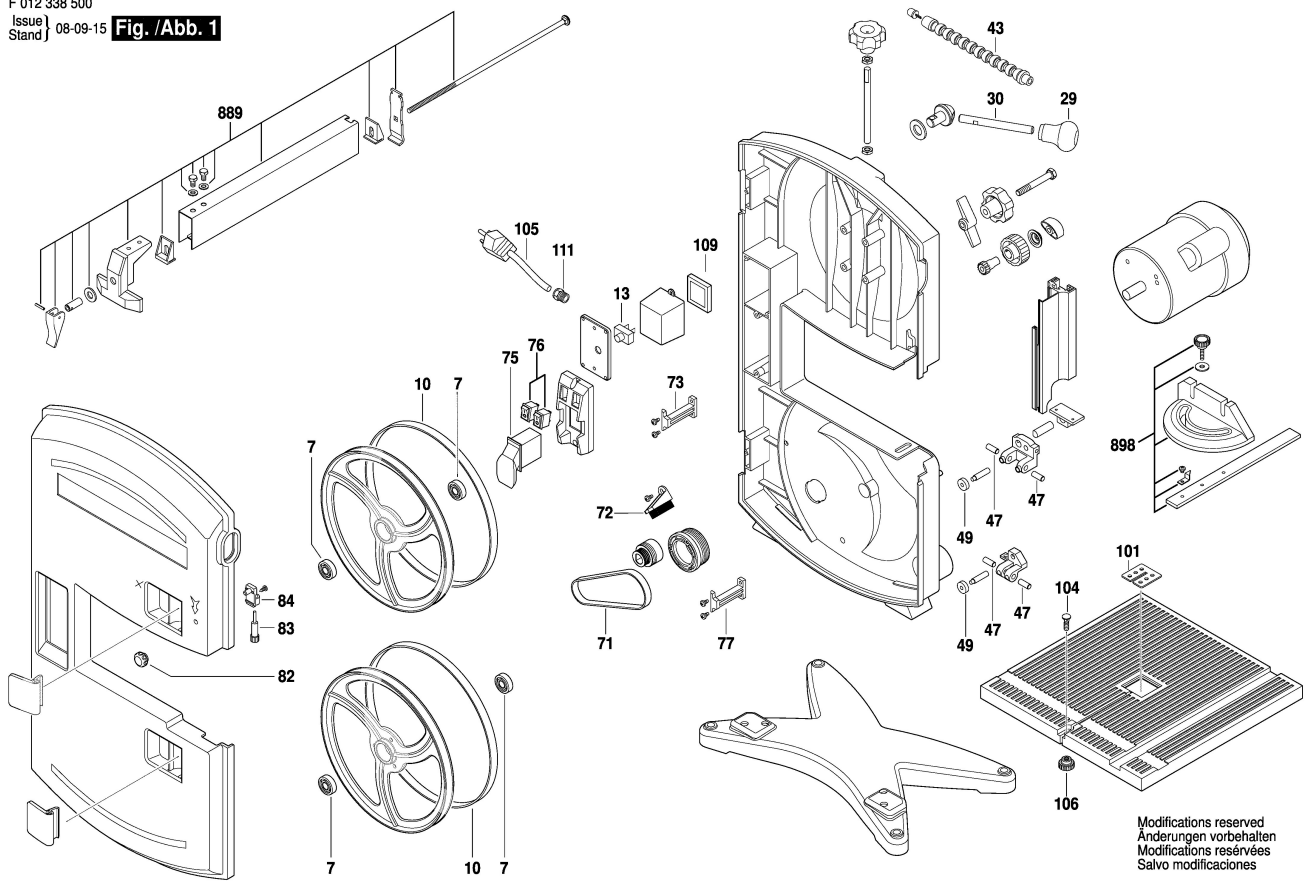

Modifications reserved  
Änderungen vorbehalten  
Modifications réservées  
Salvo modificaciones