

F012 351 005
Issue 10-05-21
Stand

Fig./Abb. 1

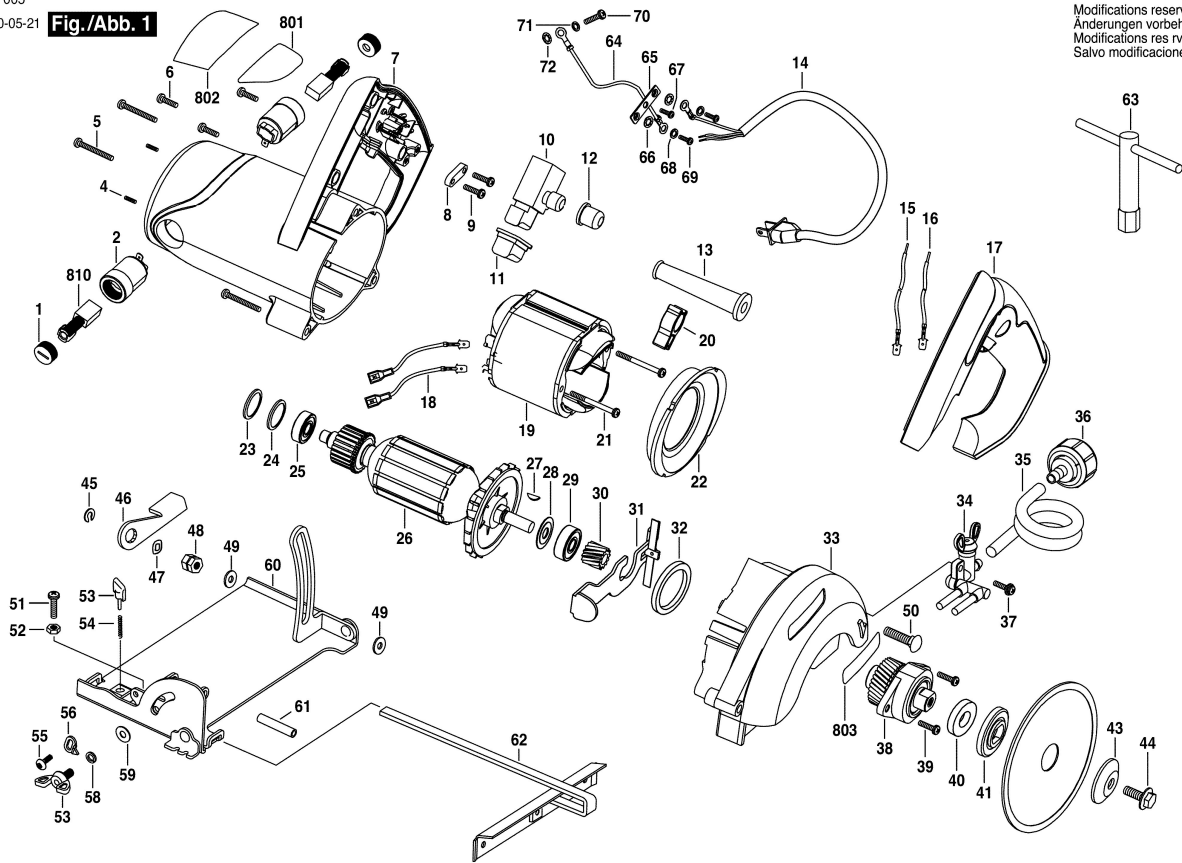

Modifications reserved
Änderungen vorbehalten
Modifications reserves
Salvo modificaciones