

F 012 429 500
Issue | 13-12-11
Stand |

Fig./Abb. 1

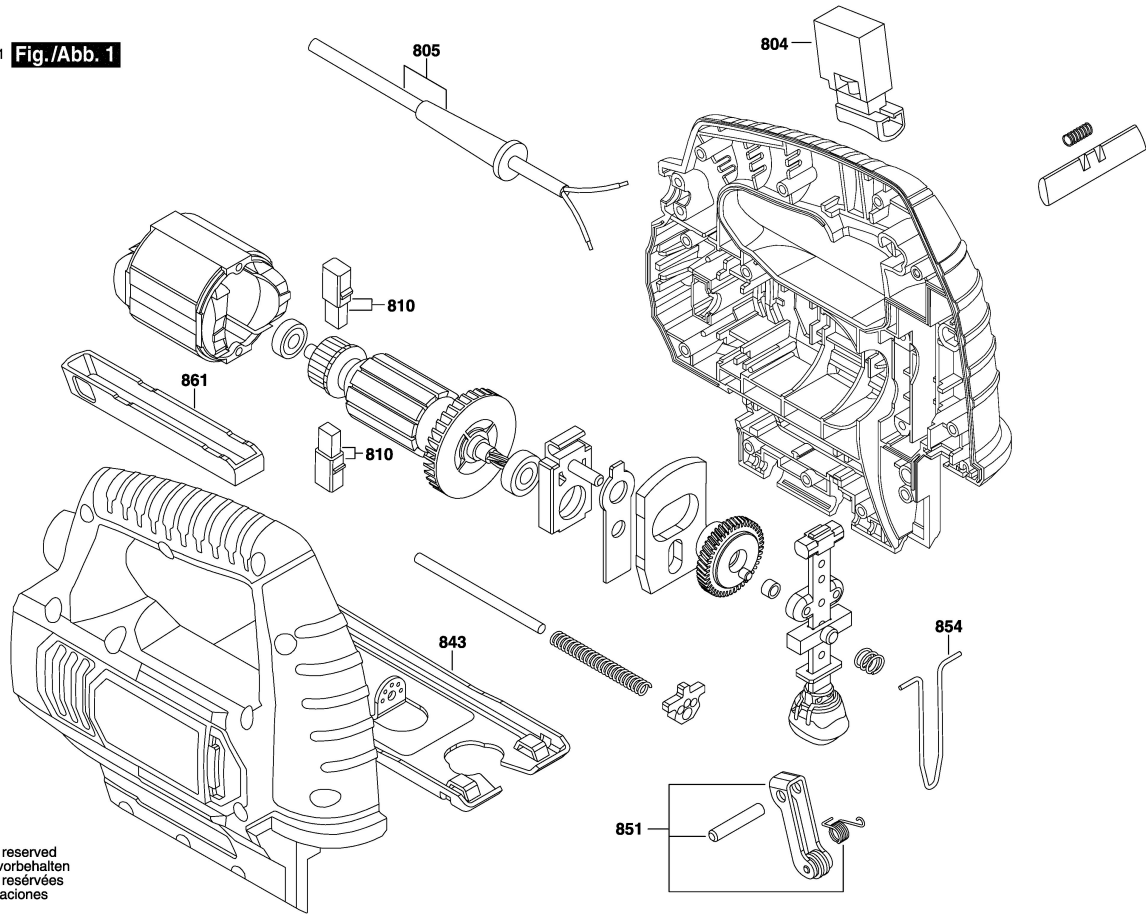

Modifications reserved
Änderungen vorbehalten
Modifications réservées
Salvo modificaciones