

F012 565 799
Issue 00-11-30
Stand

Fig./Abb. 1

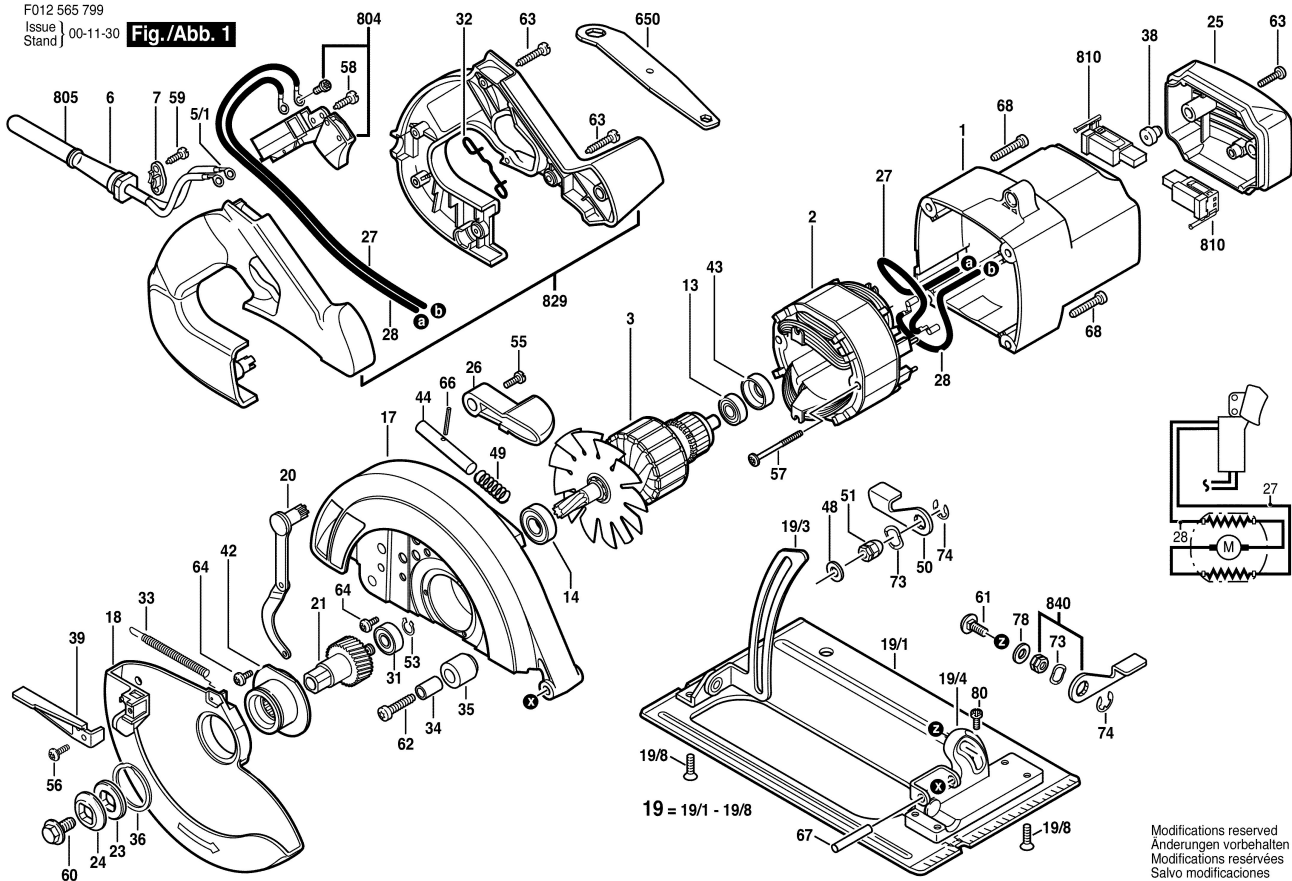

Modifications reserved
Änderungen vorbehalten
Modifications réservées
Salvo modificaciones