

F012 566 099
Issue
Stand } 00-12-18

Fig./Abb. 1

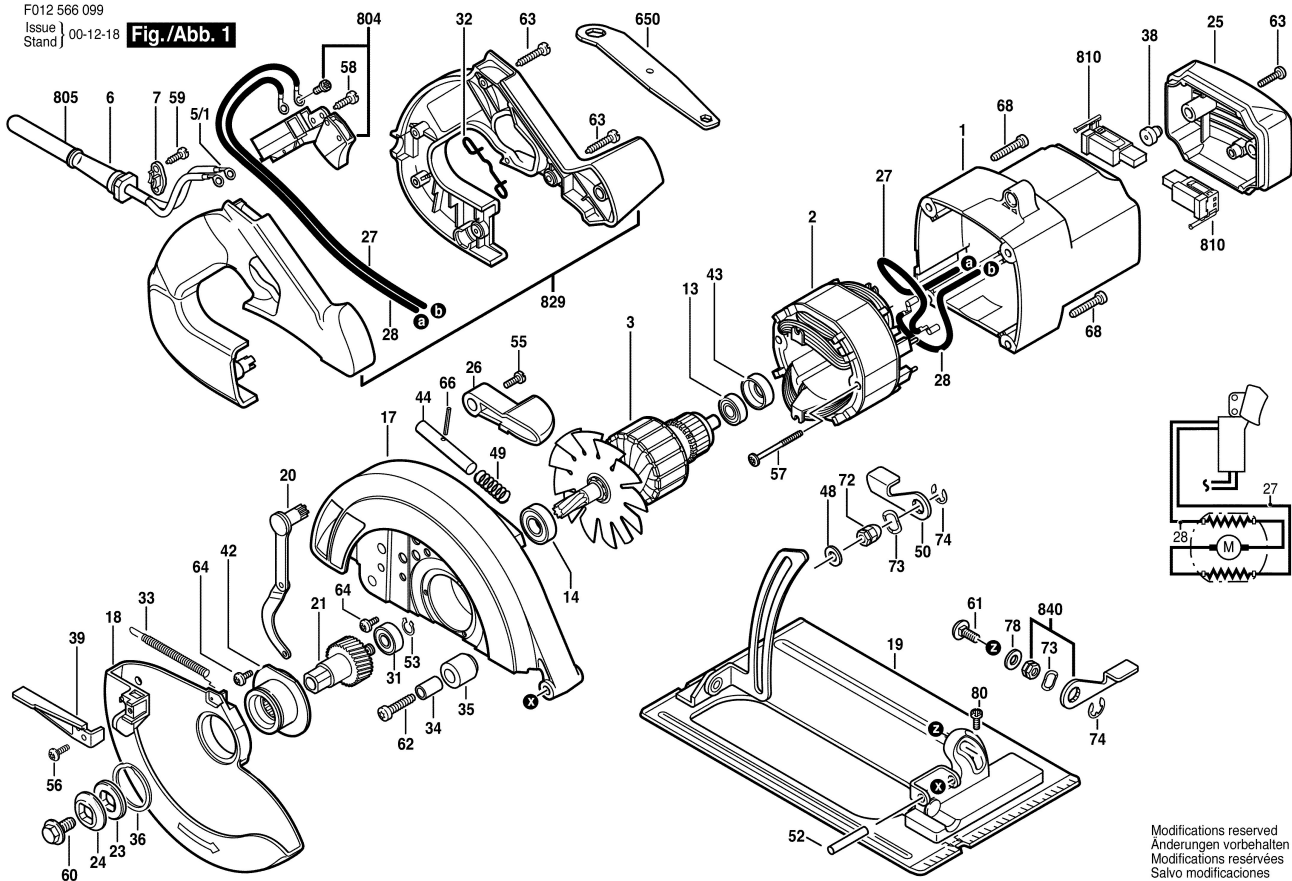

Modifications reserved
Änderungen vorbehalten
Modifications réservées
Salvo modificaciones