

F012 613 200
Issue | 08-12-04
Stand |

Fig./Abb. 1

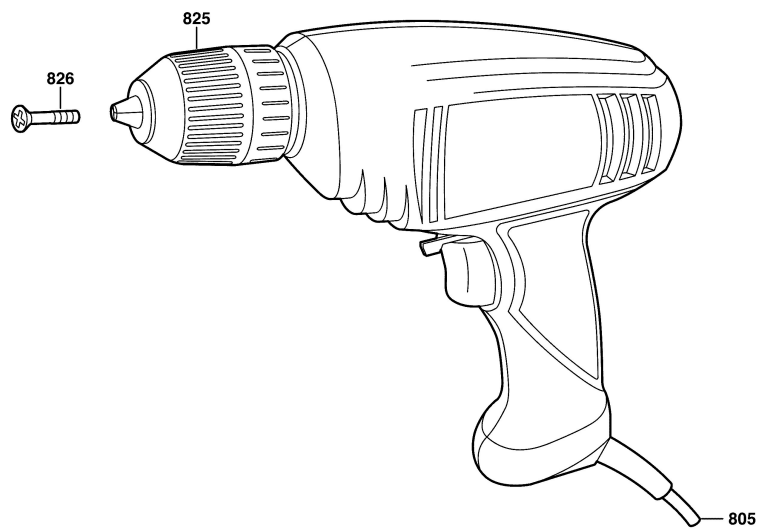

Modifications reserved
Änderungen vorbehalten
Modifications réservées
Salvo modificaciones