

F012 626 000  
Issue 01-10-02  
Stand

**Fig./Abb. 1**

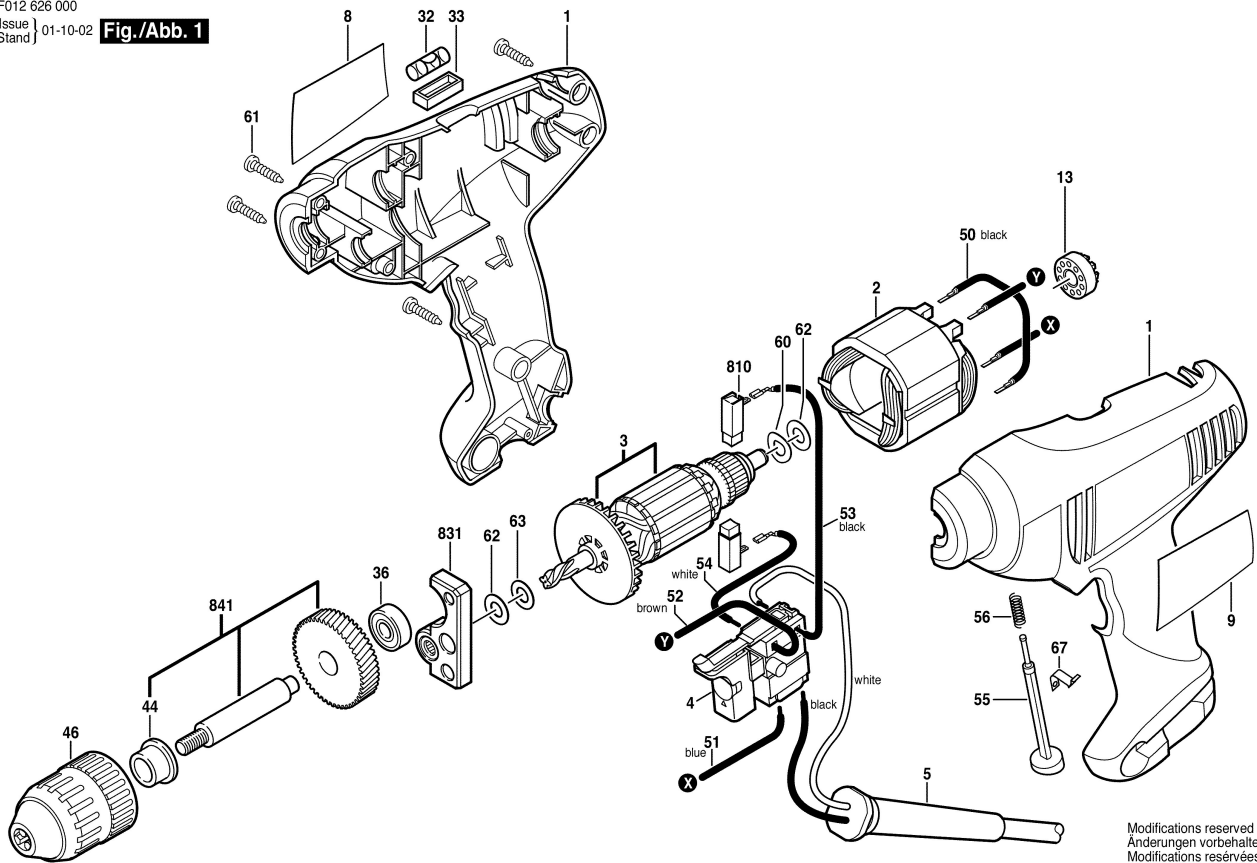

Modifications reserved  
Änderungen vorbehalten  
Modifications réservées  
Salvo modificaciones