

F012 6325 01  
Issue  
Stand

Fig./Abb. 1

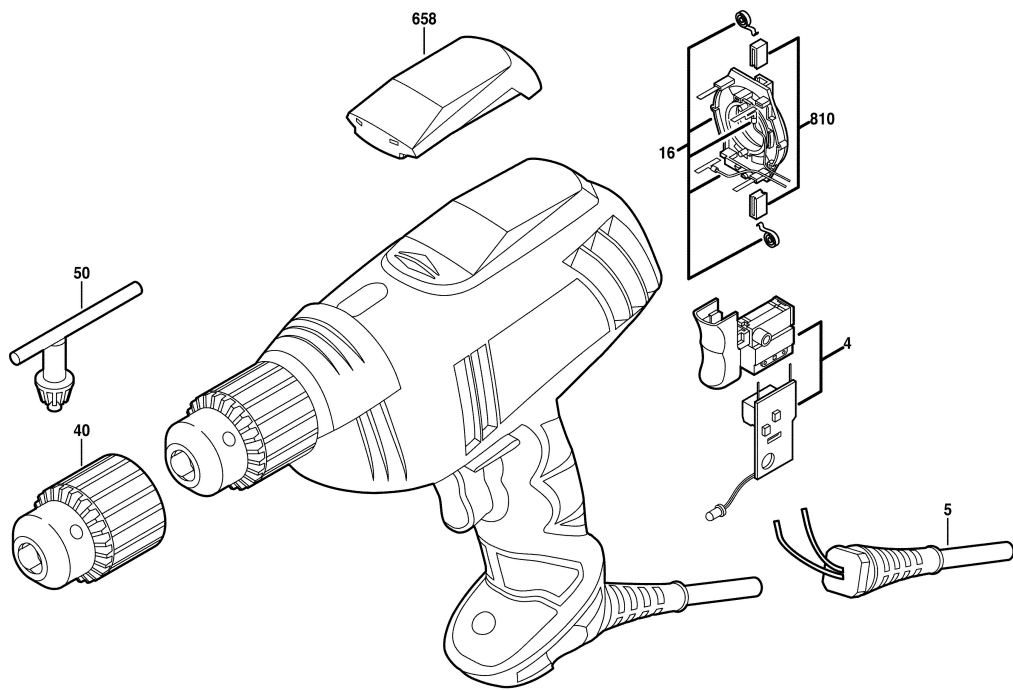

Modifications reserved  
Änderungen vorbehalten  
Modifications réservées  
Salvo modificaciones