

F012 633 544
Issue }
Stand }00-11-06

Fig./Abb. 1

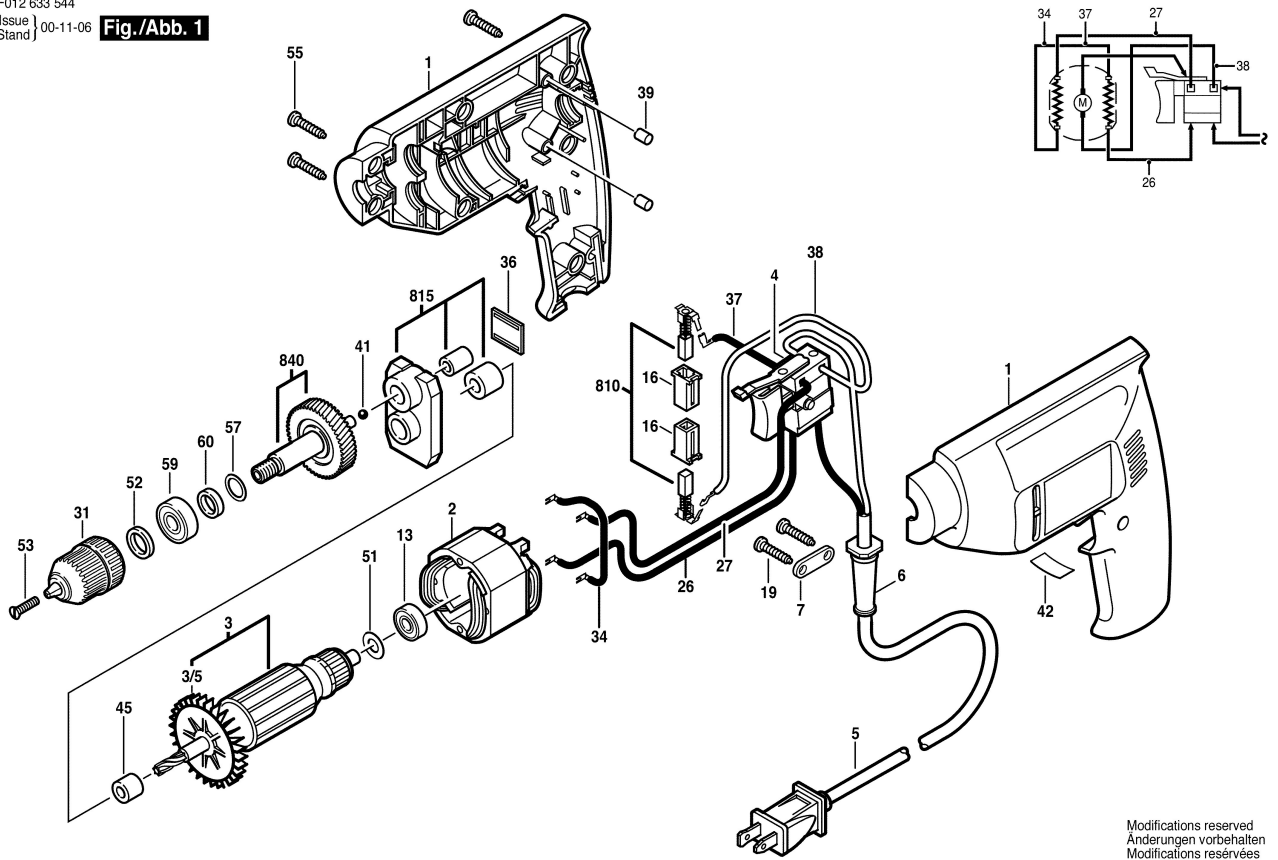

Modifications reserved
Änderungen vorbehalten
Modifications réservées
Salvo modificaciones