

F 012 646 400

Stand } 99-01-18
Issue }

Fig./Abb. 1

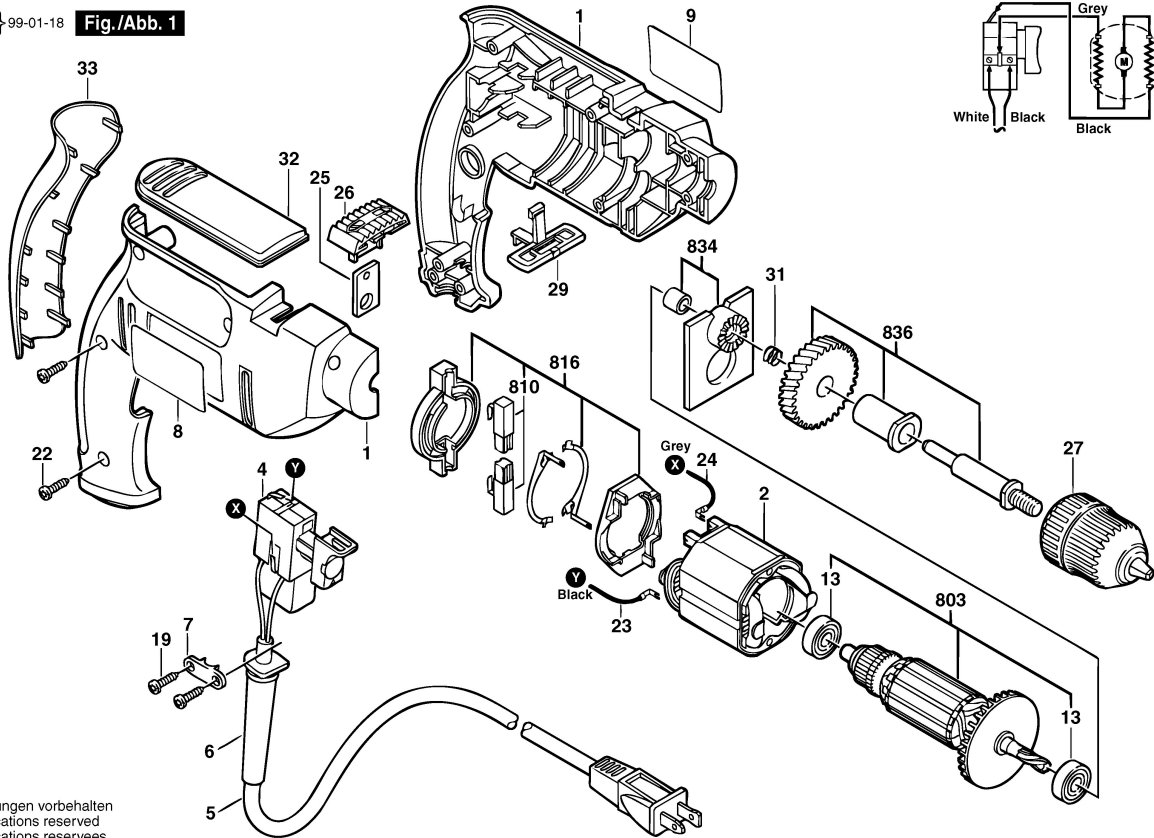

Änderungen vorbehalten
Modifications reserved
Modifications reserves
Salvo modificaciones