

F 012 657 000

Stand | 12-96
Issue | 14-06-16

Fig./Abb. 1

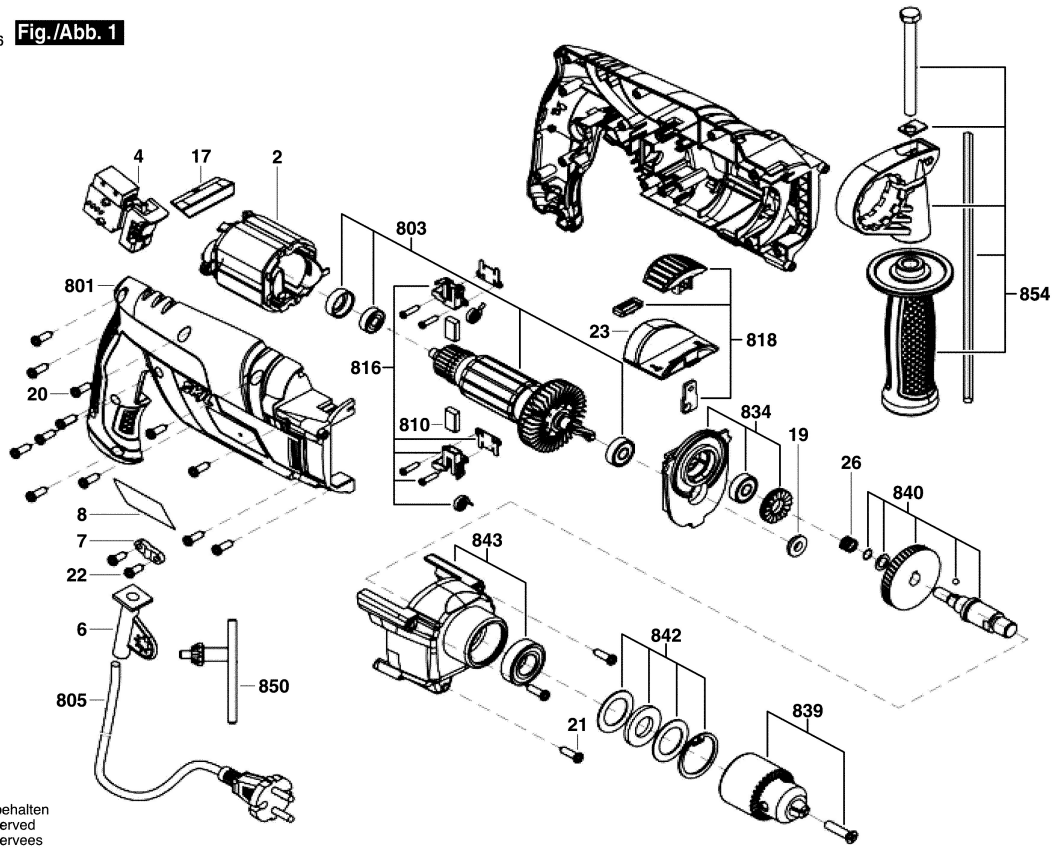

Änderungen vorbehalten
Modifications reserved
Modifications reserves
Salvo modificaciones