

F 012 664 001
Stand 1 07-06
Issue J 08-06-26

Fig./Abb. 1

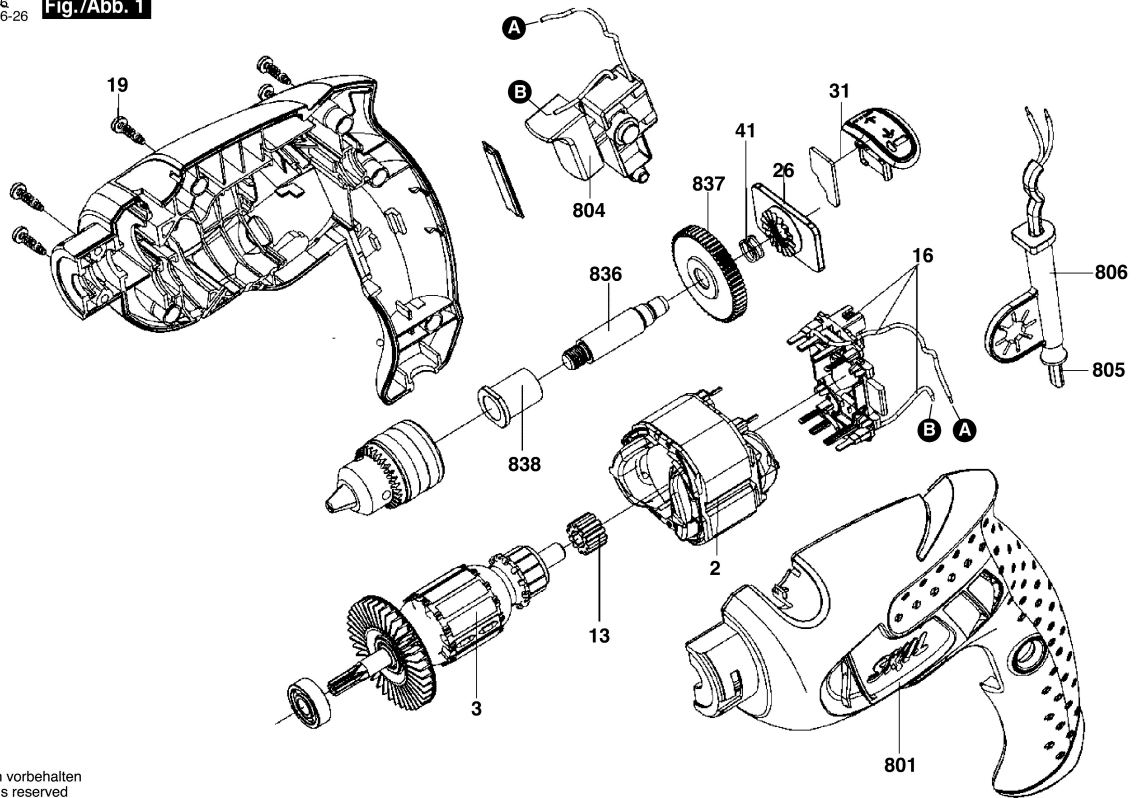

Änderungen vorbehalten
Modifications reserved
Modifications reserves
Salvo modificaciones