

F012674000

Stand
Issue J 00-06-01

Fig./Abb. 1

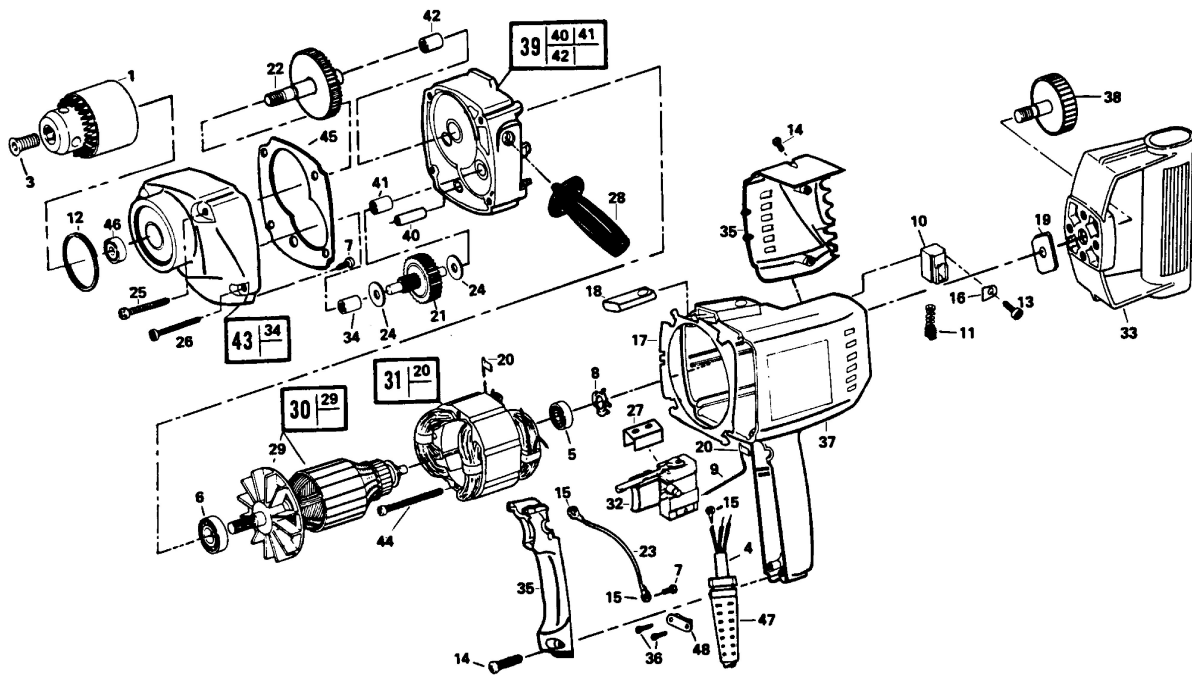

änderungen vorbehalten
Modifications reserved
Modificaciones reservadas
Salvo modificaciones