

F012690699

Stand
Issue J 00-05-22

Fig./Abb. 1

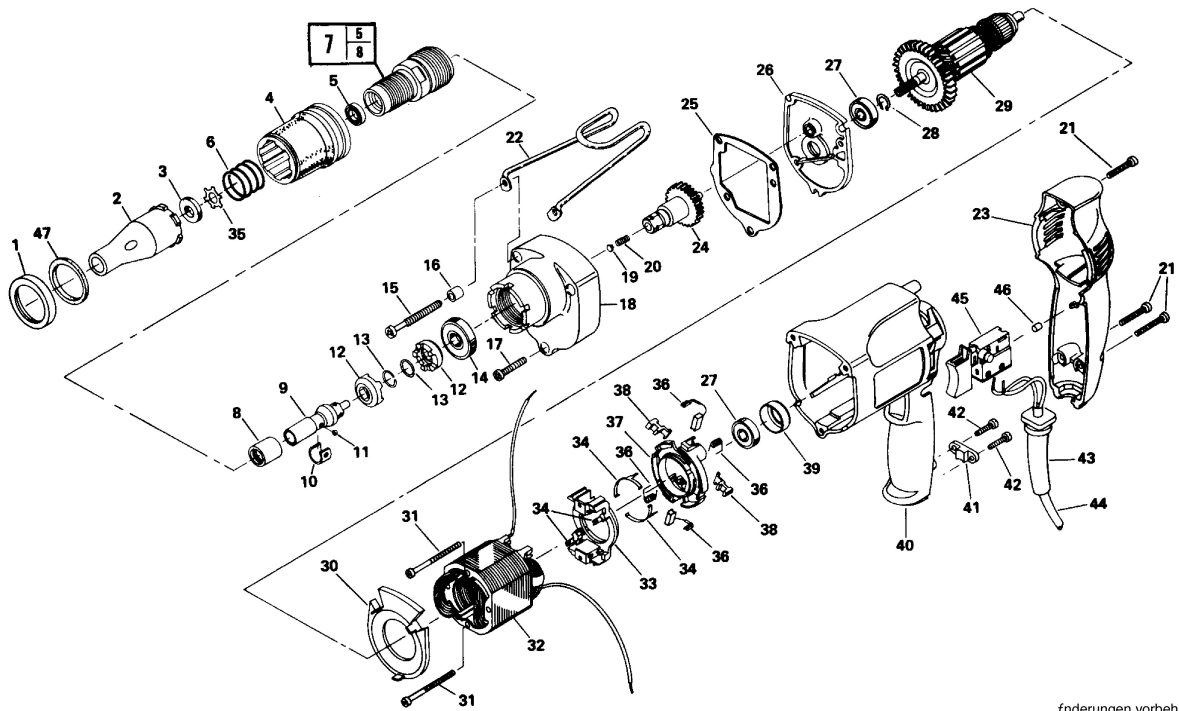

änderungen vorbehalten
Modifications reserved
Modificaciones reservadas
Salvo modificaciones