

F012690800

Stand
Issue J 00-05-25

Fig./Abb. 1

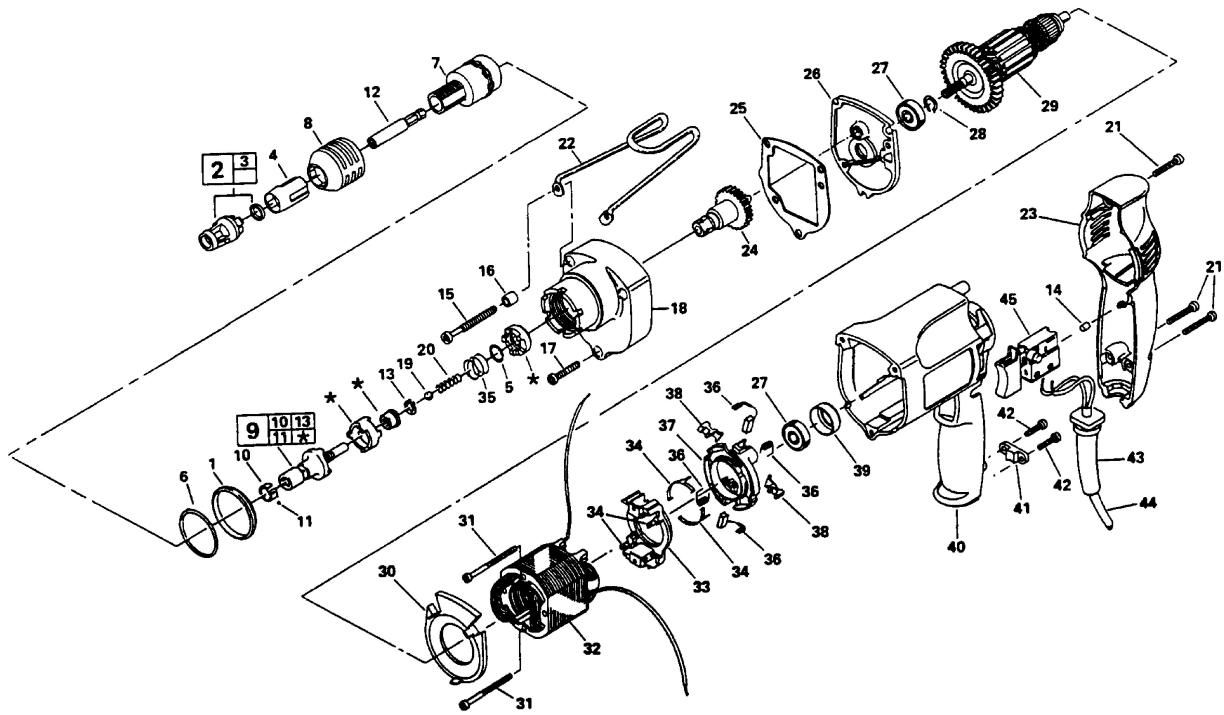

änderungen vorbehalten
Modifications reserved
Modificaciones reservadas
Salvo modificaciones