

F012691200

Stand
Issue J 00-05-25

Fig./Abb. 1

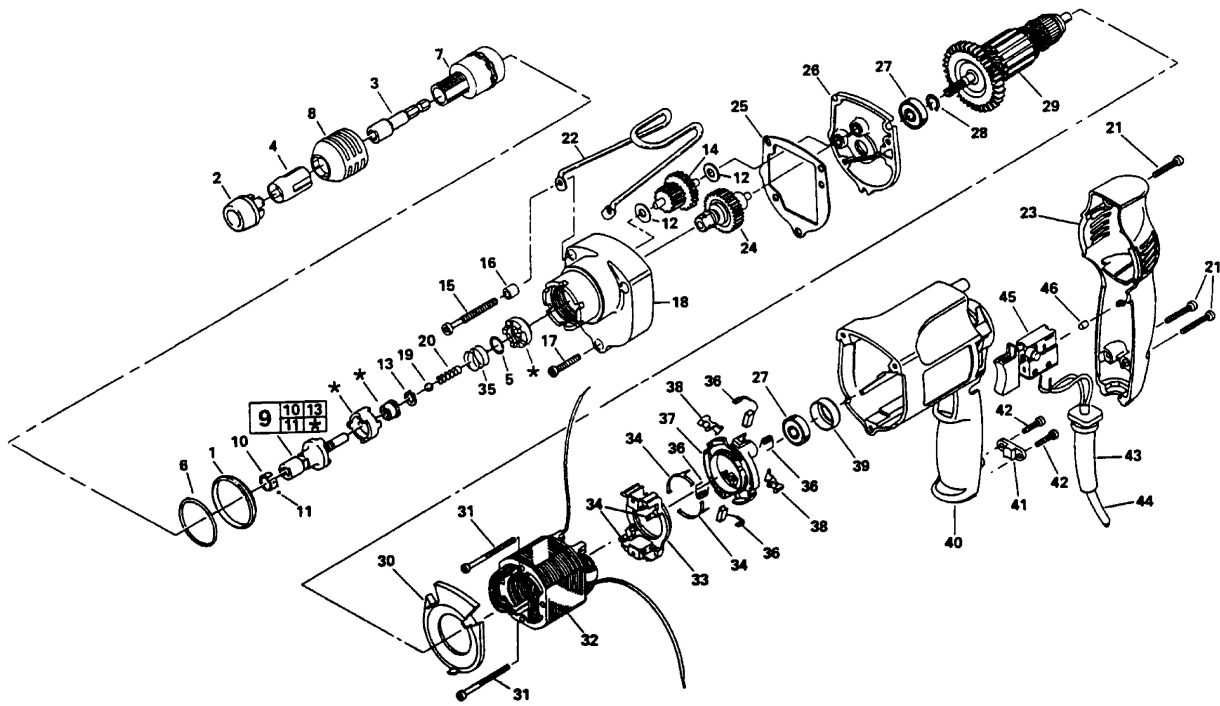

Änderungen vorbehalten
Modifications reserved
Modificacions reservadas
Salvo modificaciones