

F 012 900 600

Stand } 13-02-27
Issue }

Fig./Abb. 1

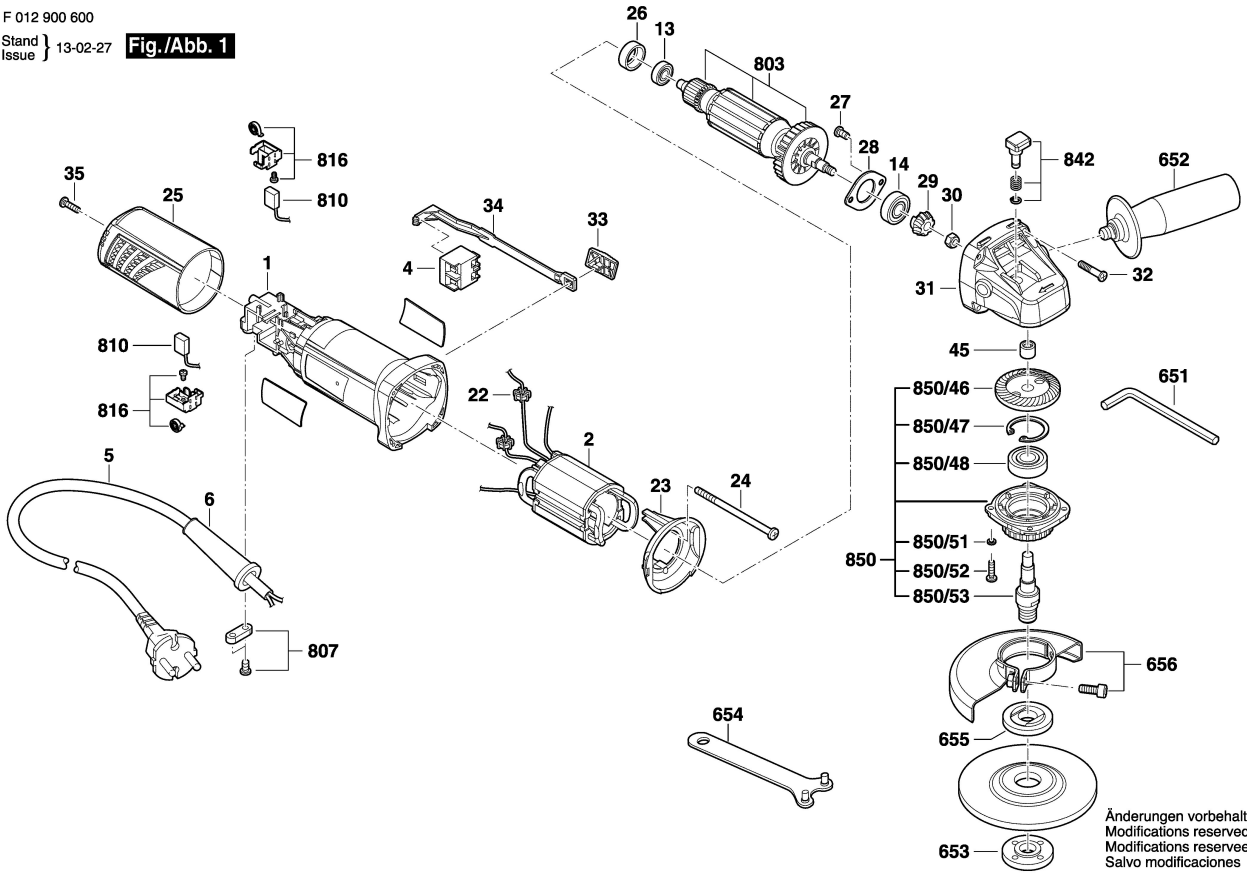

Änderungen vorbehalten
Modifications reserved
Modificaciones reservadas
Salvo modificaciones