

F012 905 100  
Issue }  
Stand } 13-08-15

Fig./Abb. 1

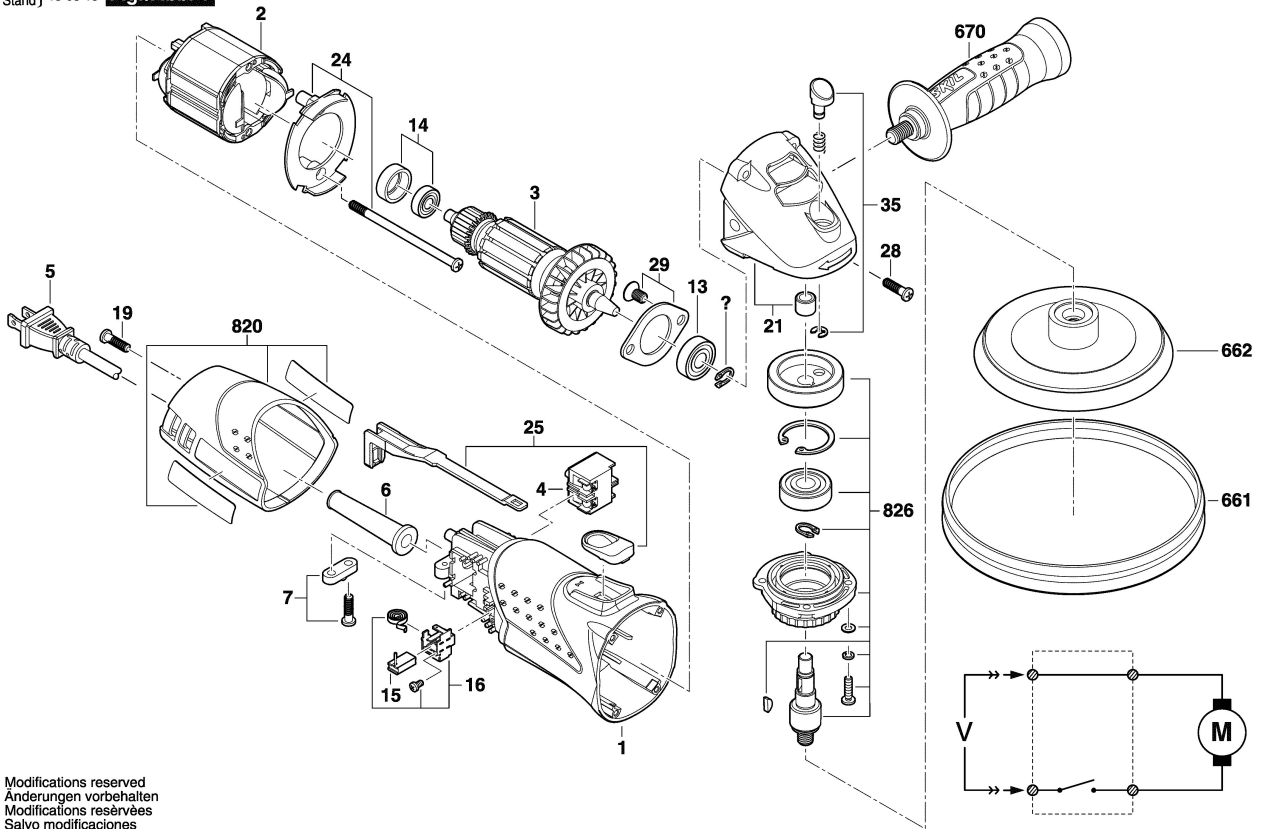

Modifications reserved  
Änderungen vorbehalten  
Modifications réservées  
Salvo modificaciones