

F012 931 000
Issue }
Stand } 00-11-10

Fig./Abb. 1

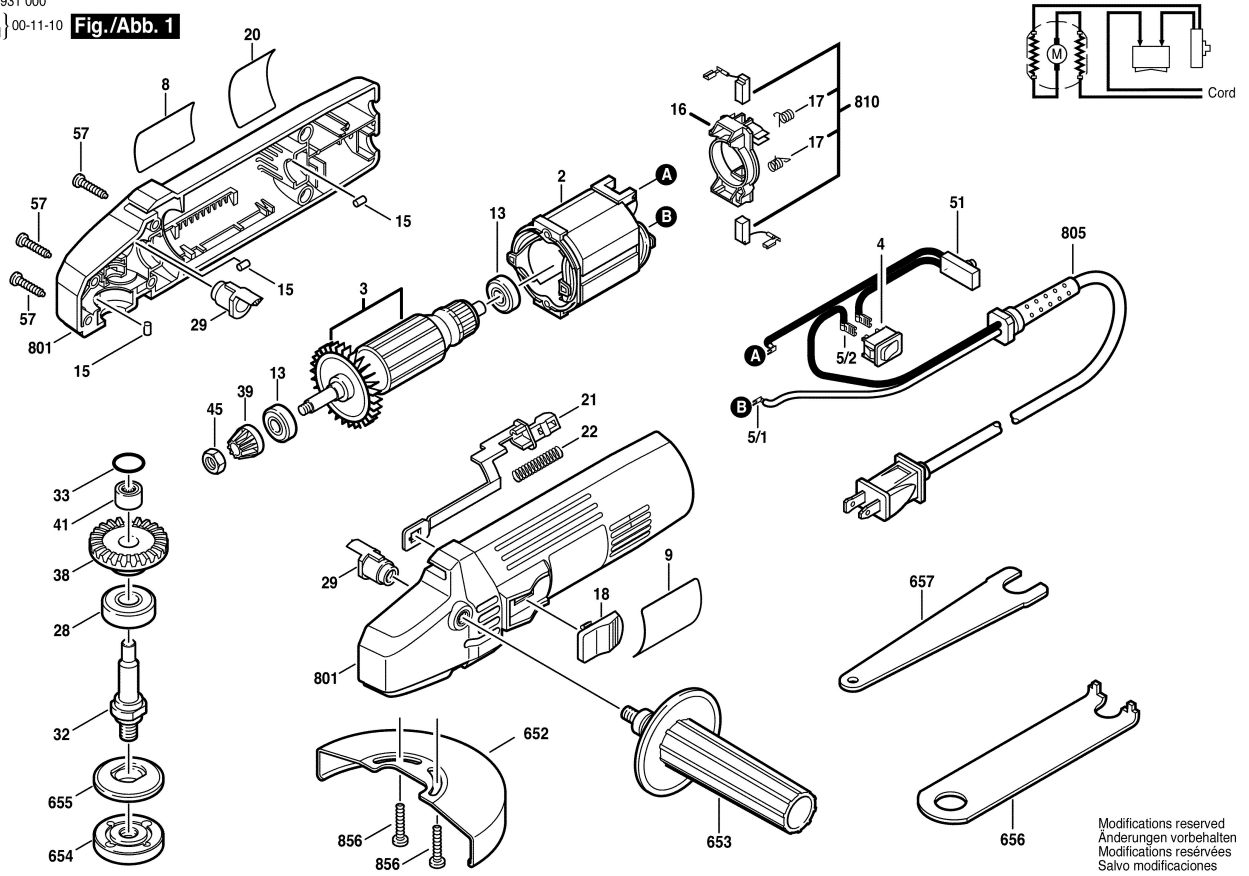

Modifications reserved
Änderungen vorbehalten
Modifications réservées
Salvo modificaciones