

F012 935 100  
Issue 10-11-19  
Stand

**Fig./Abb. 1**

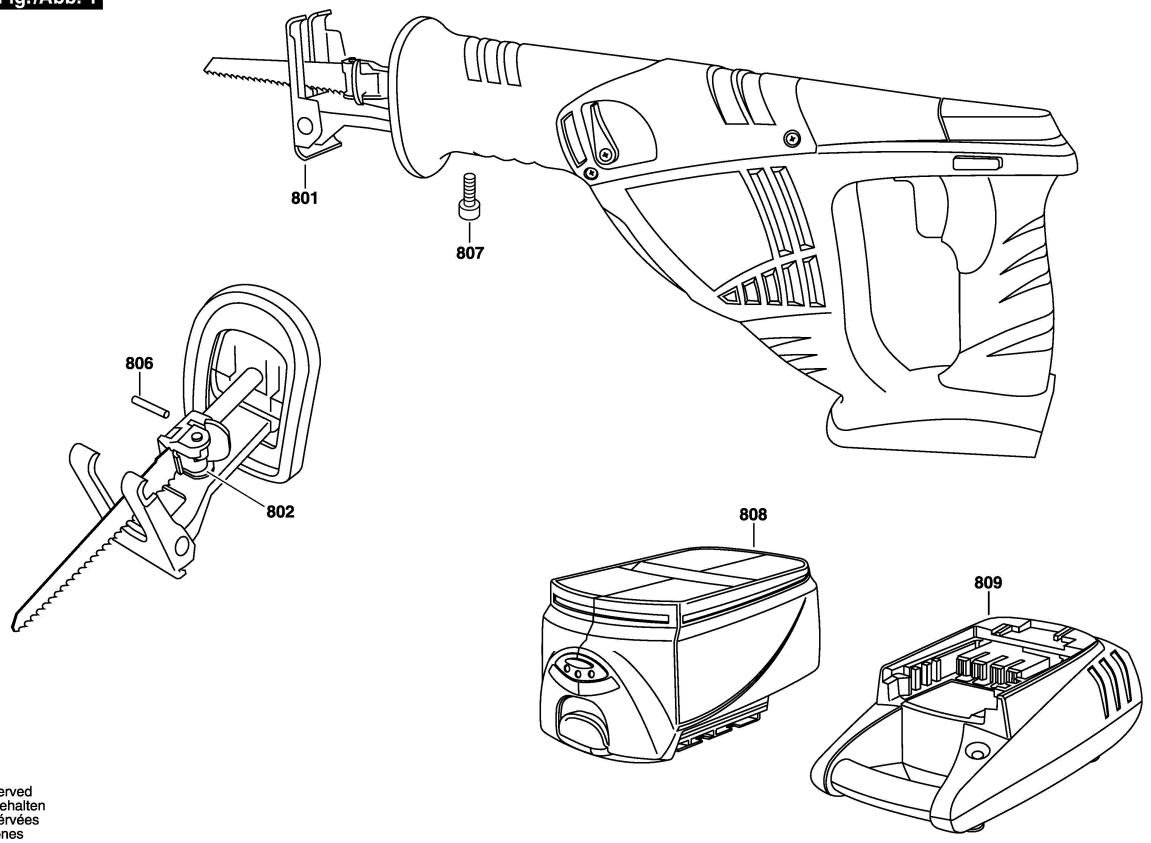

Modifications reserved  
Änderungen vorbehalten  
Modifications réservées  
Salvo modificaciones