

F012SD7705

Stand Issue 07-04-20

Fig./Abb. 1

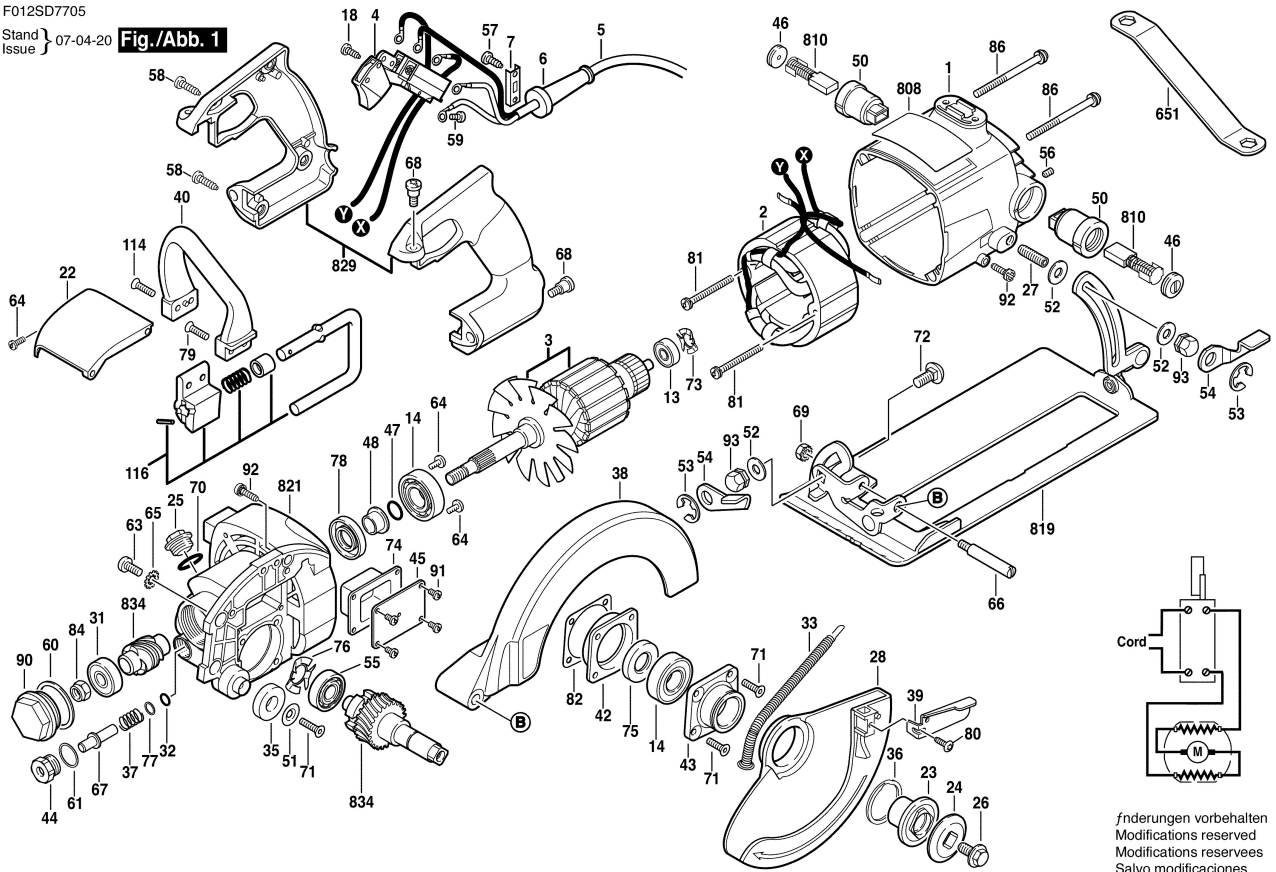

Änderungen vorbehalten  
Modifications reserved  
Modificaciones reservadas  
Salvo modificaciones