

F012SD7712

Stand Issue 09-03-04

Fig./Abb. 1

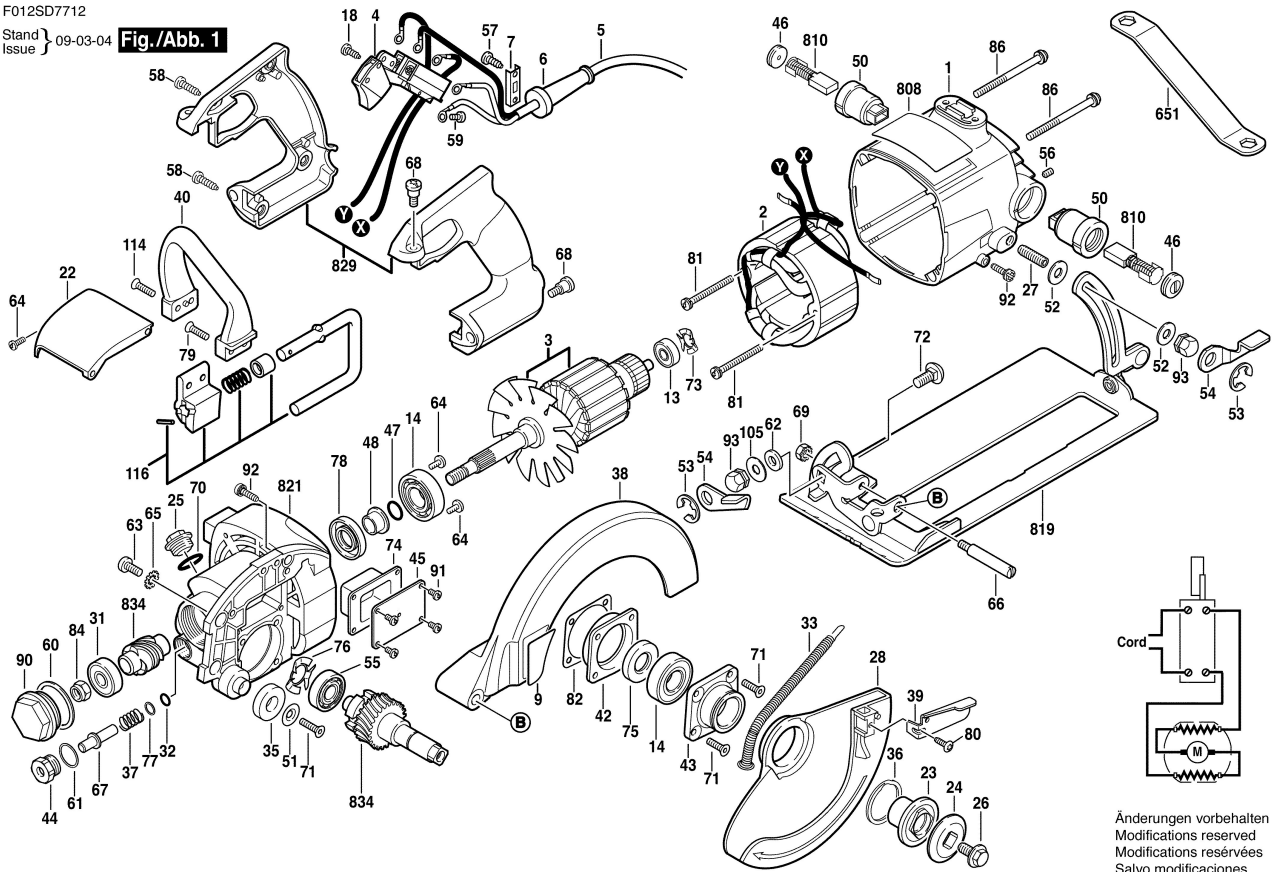

Änderungen vorbehalten  
Modifications reserved  
Modifications réservées  
Salvo modificaciones