

F012 663 500
Issue
Stand | 00-11-09

Fig./Abb. 1

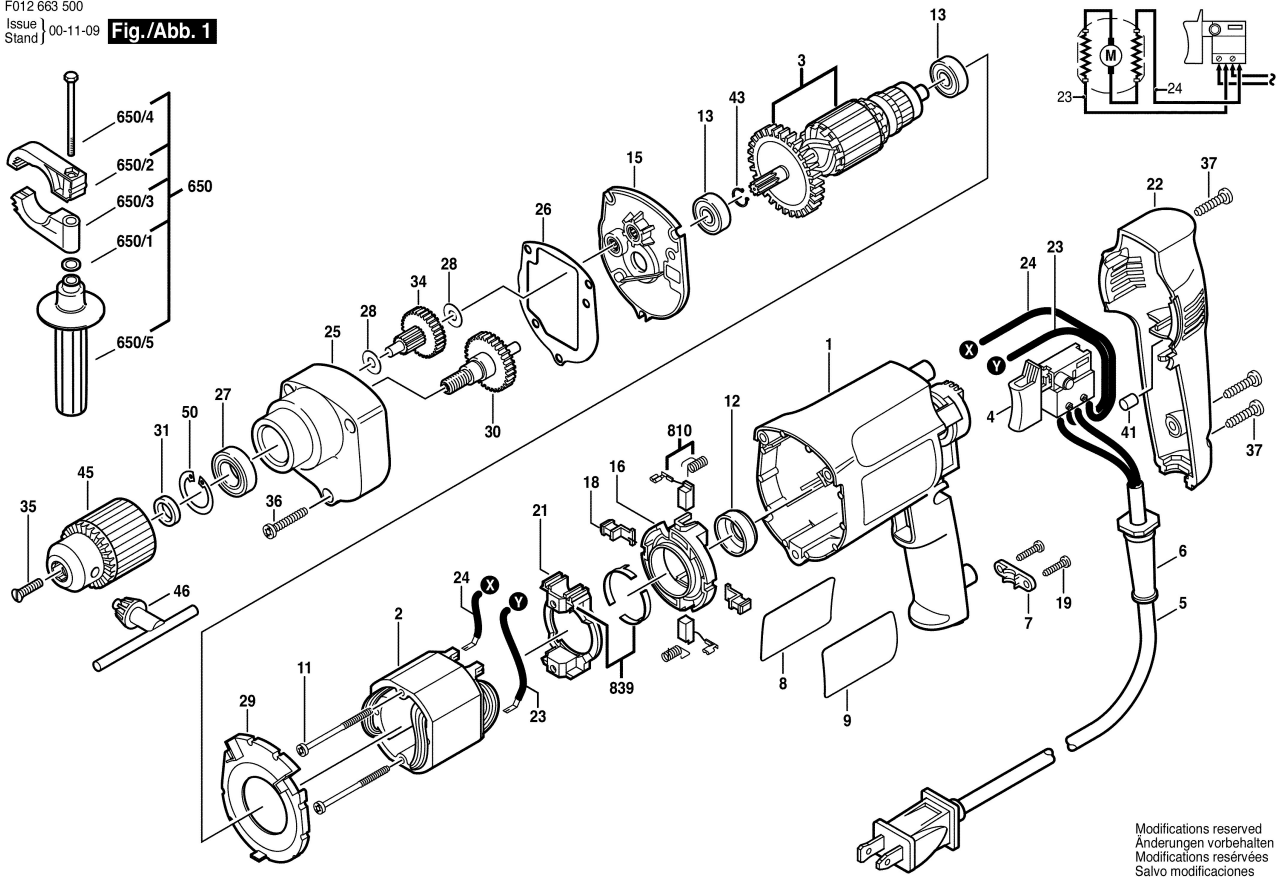

Modifications reserved
Änderungen vorbehalten
Modifications réservées
Salvo modificaciones