

F 013 110 045
Stand 06-05-24
Issue

Fig./Abb. 1

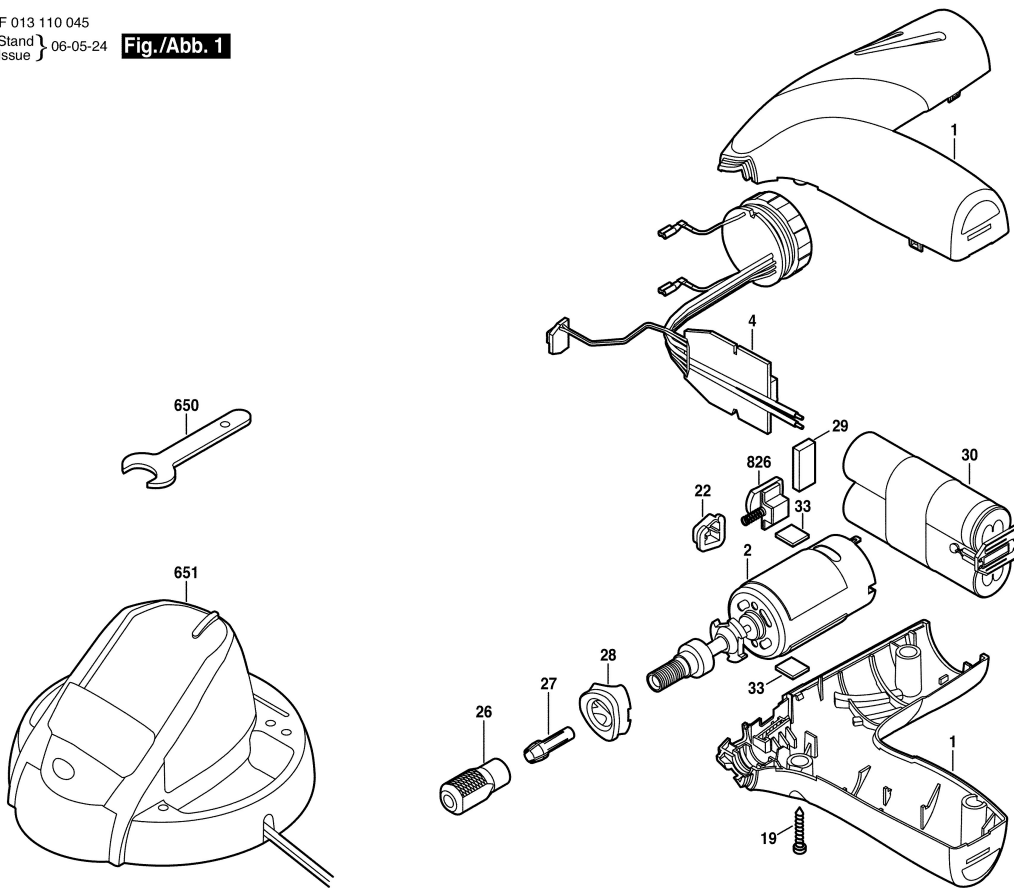

Änderungen vorbehalten
Modifications reserved
Modificaciones reservadas