

F 013 400 045
Stand } 10-01-21
Issue }

Fig. /Abb. 1

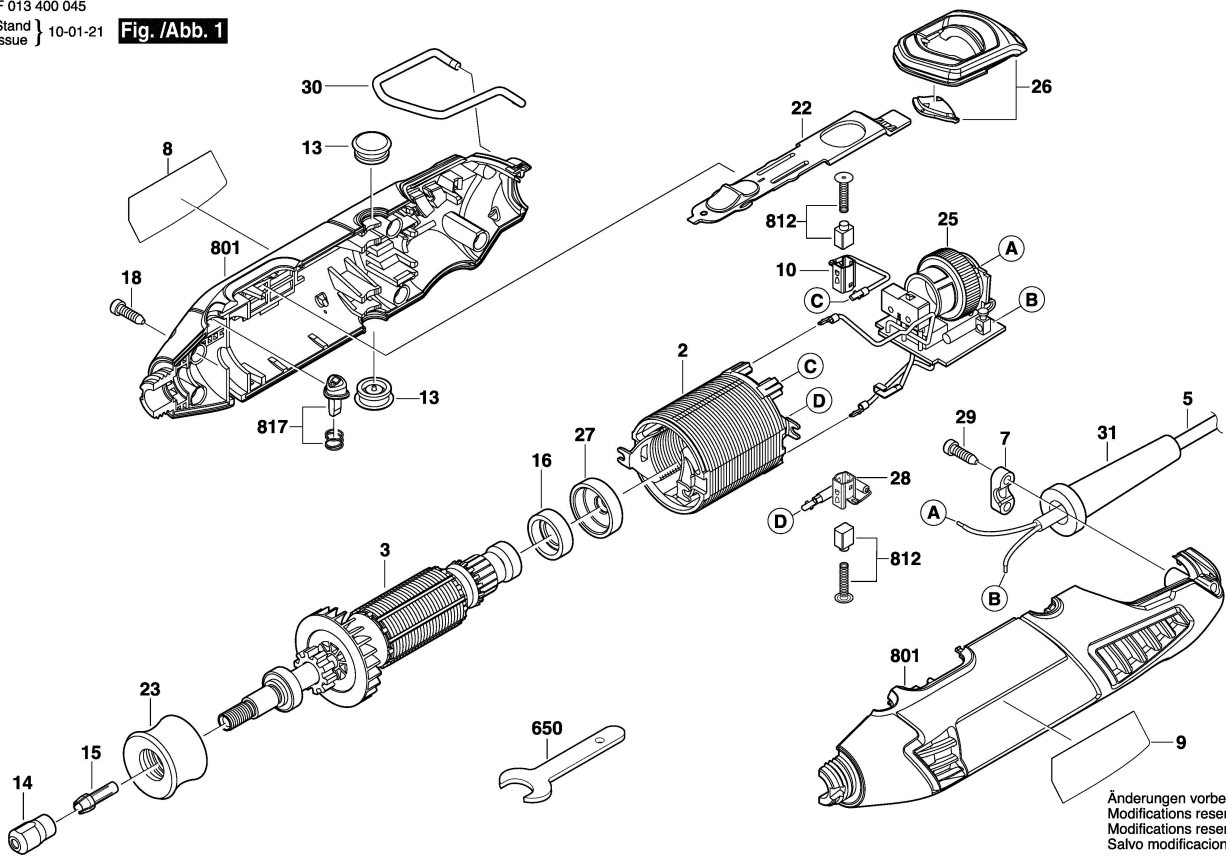

Änderungen vorbehalten
Modifications reserved
Modificacions reserves
Salvo modificaciones