

F 013 600 00A  
Stand | 38-16  
Issue | 98-09-28

**Fig./Abb. 1**

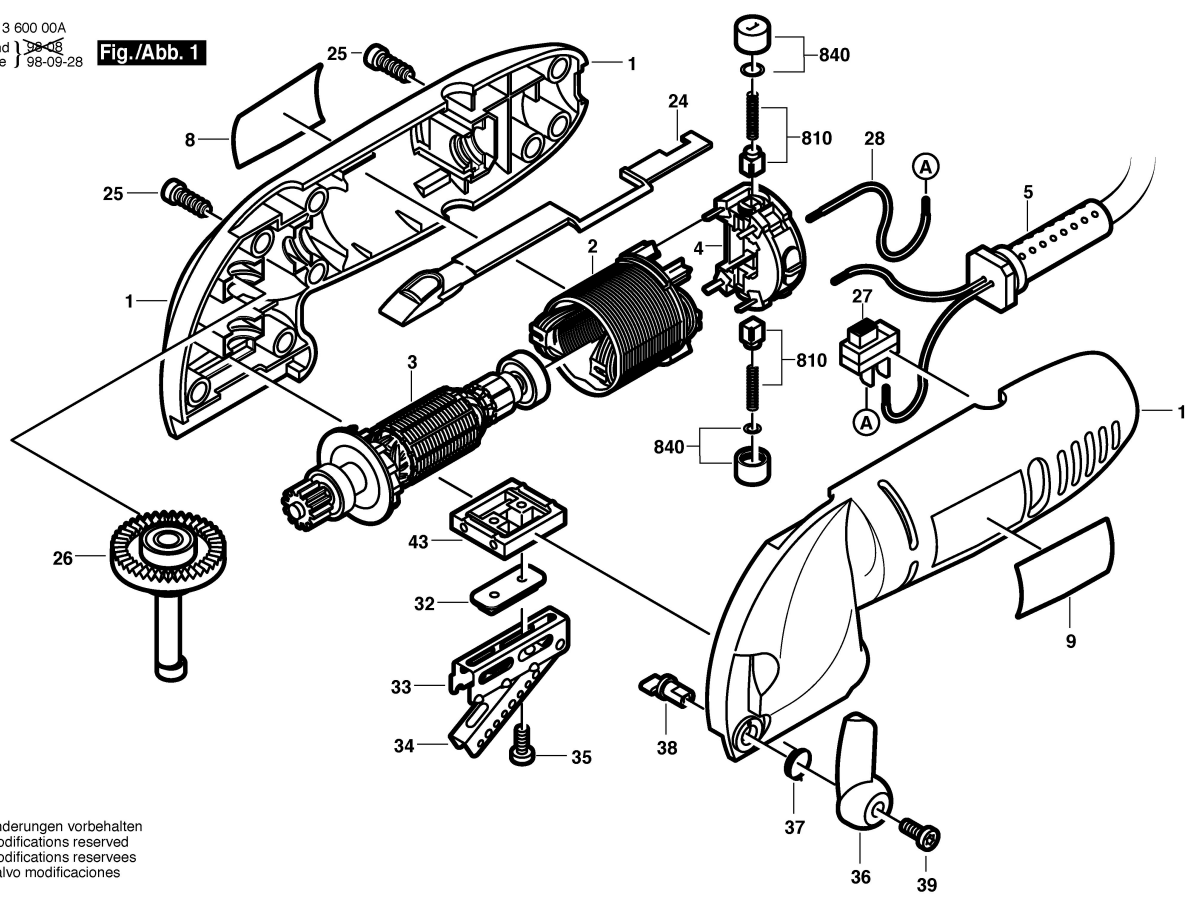

Änderungen vorbehalten  
Modifications reserved  
Modificacions reserves  
Salvo modificaciones