

F 013 780 066
Stand 11-06
Issue J 01-07-30

Fig./Abb. 1

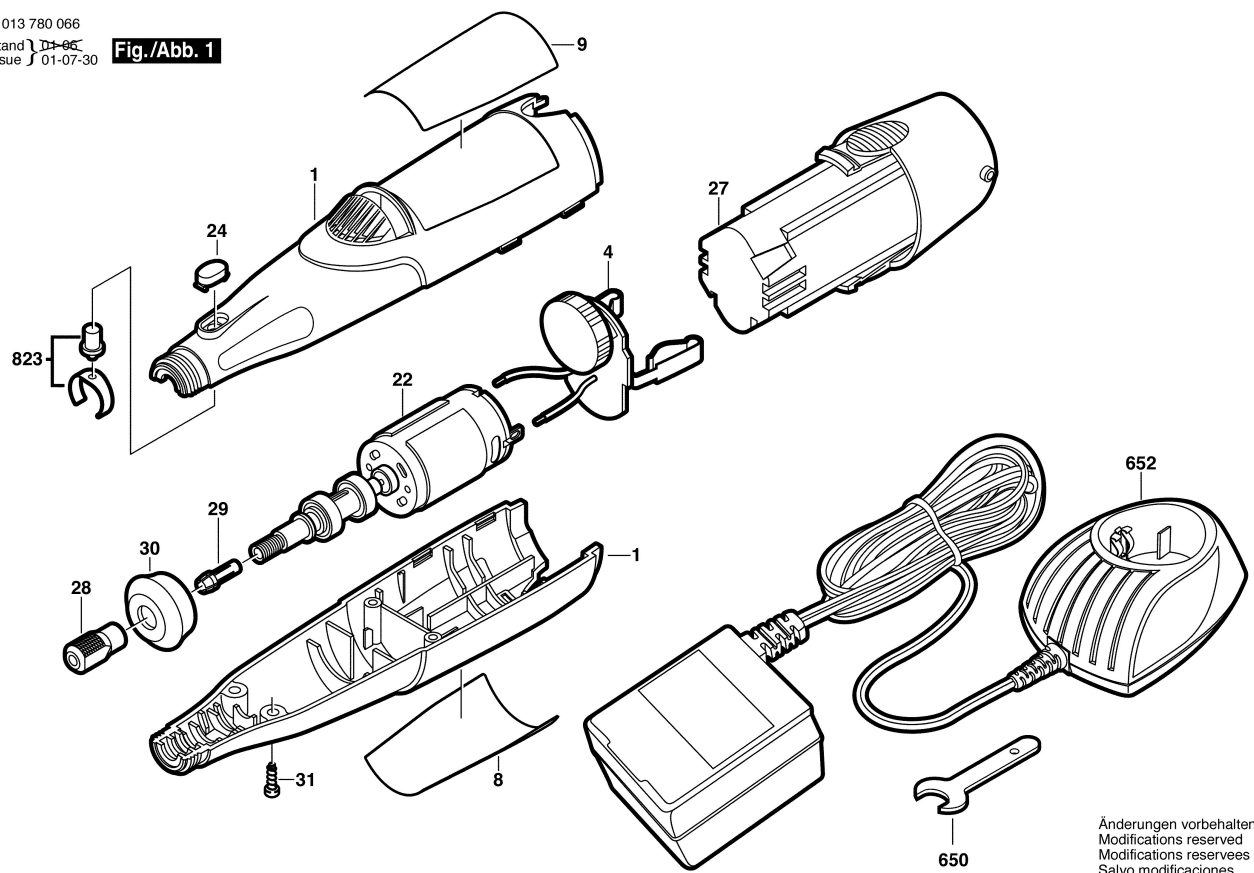

Änderungen vorbehalten
Modifications reserved
Modificacions reserves
Salvo modificaciones