

F 013 810 045

Stand } 12-10-05 **Fig./Abb. 1**

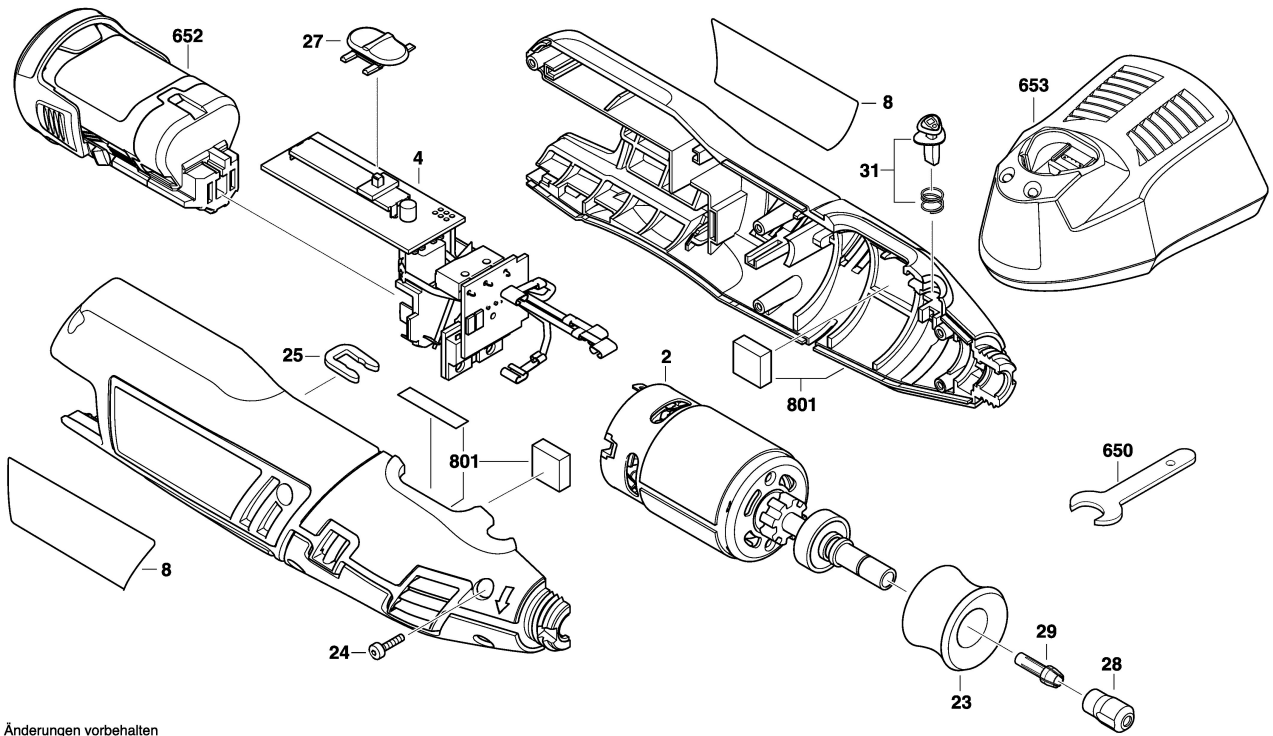

Änderungen vorbehalten
Modifications reserved
Modifications réservées
Salvo modificaciones