

F 013 822 000

Stand } 12-05-09 **Fig./Abb. 1**

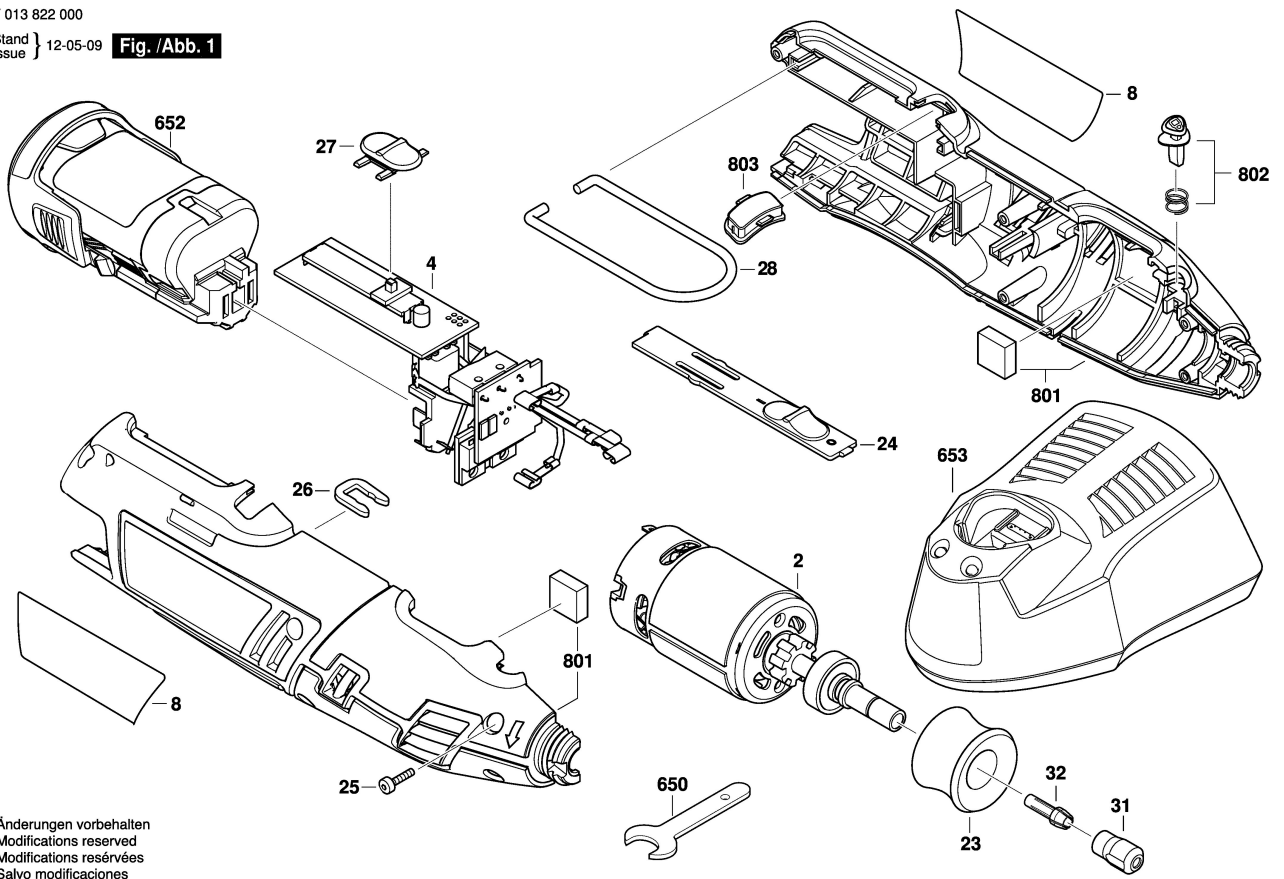

Änderungen vorbehalten
Modifications reserved
Modifications réservées
Salvo modificaciones