

F013 830 000
Issue 10-08-31
Stand

Fig./Abb. 1

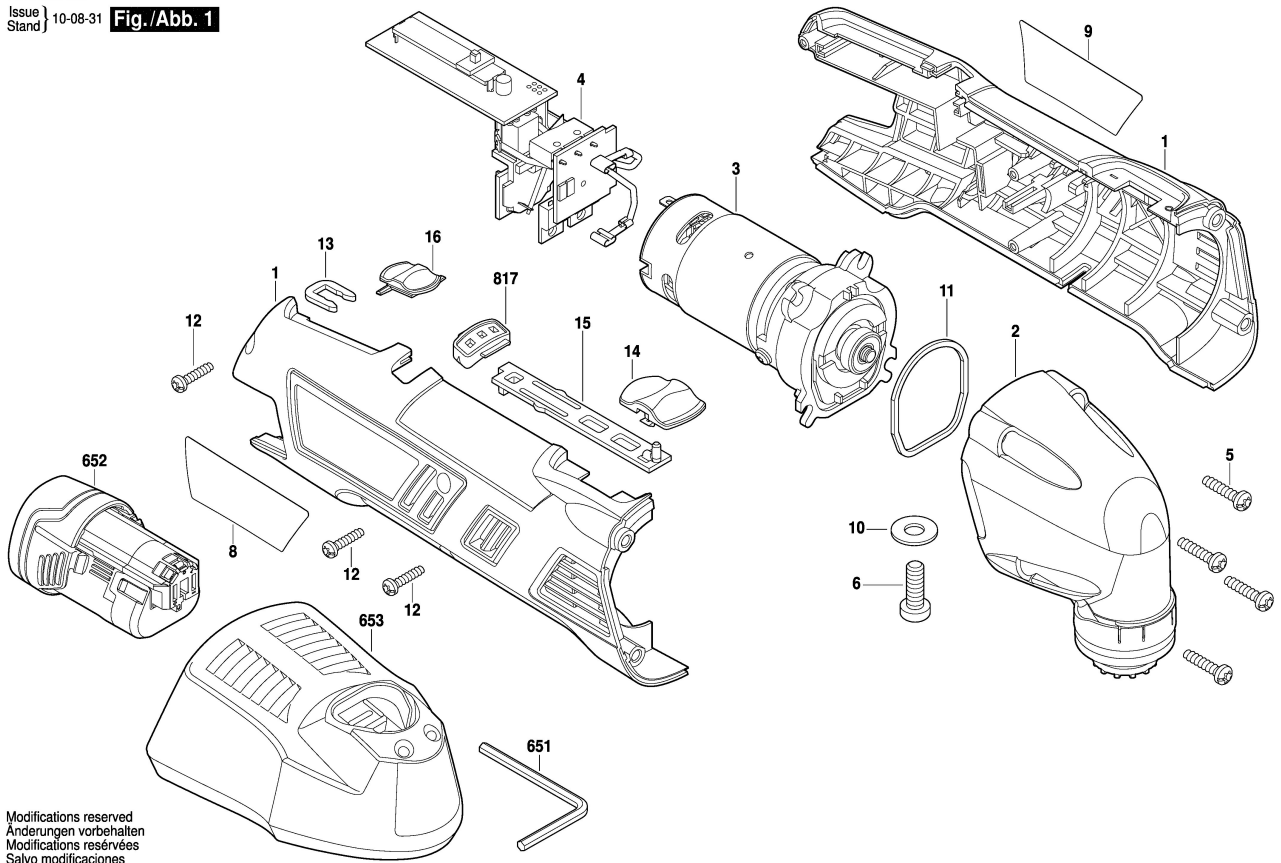

Modifications reserved
Änderungen vorbehalten
Modifications réservées
Salvo modificaciones