

F 015 050 001

Stand } 04-06-22 **Abb./Fig. 1**
Issue }

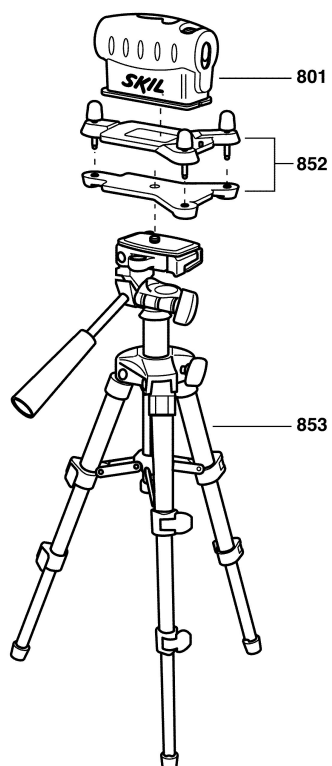

Änderungen vorbehalten
Modifications reserved
Modificaciones reserves
Salvo modificaciones