

F 015 051 501

Stand } 05-03-24 **Abb./Fig. 1**
Issue }

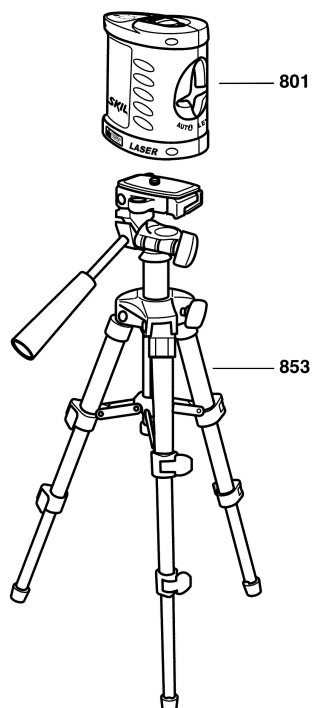

Änderungen vorbehalten
Modifications reserved
Modificaciones reservadas
Salvo modificaciones