

F 015 073 001

Stand | 10-08-17
Issue | 11-01-31 **Abb. / Fig. 1**

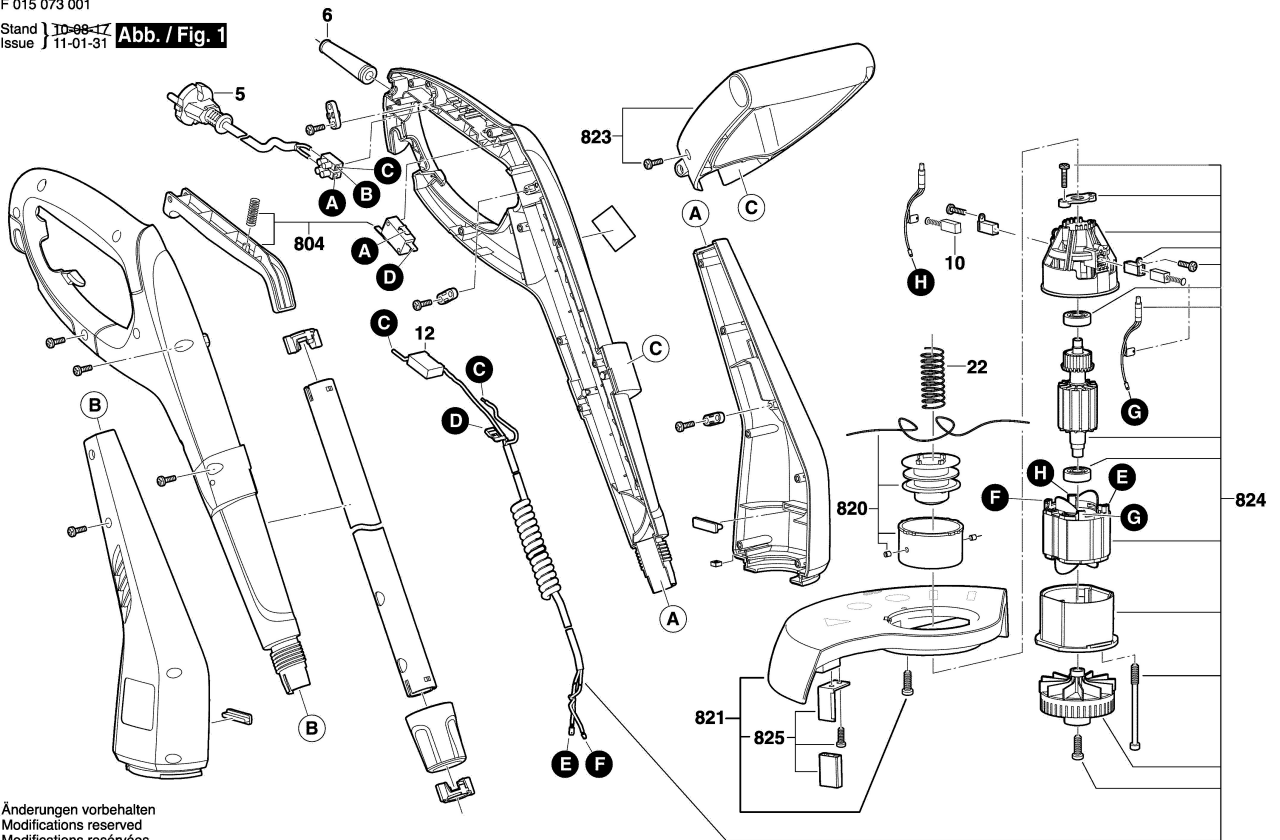

Änderungen vorbehalten
Modifications reserved
Modifications réservées
Salvo modificaciones