

F 015 101 201

Stand } 13-10-24
Issue }

Fig. /Abb. 1

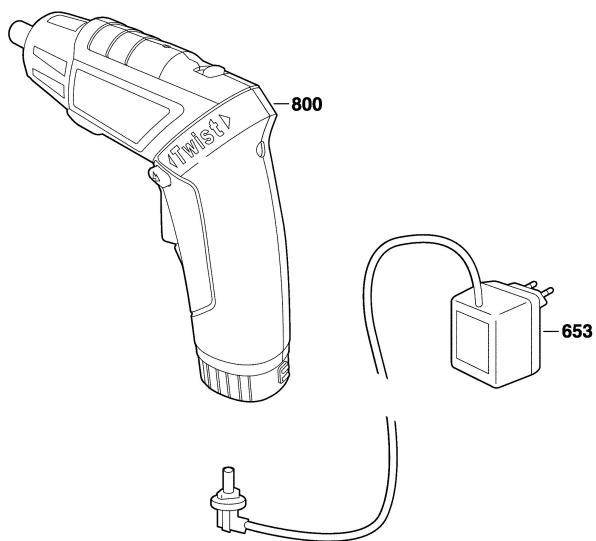

Änderungen vorbehalten
Modifications reserved
Modificaciones reservadas
Salvo modificaciones