

F 015 104 801  
Stand | 10-03  
Issue | 10-04-22

**Fig. /Abb. 1**

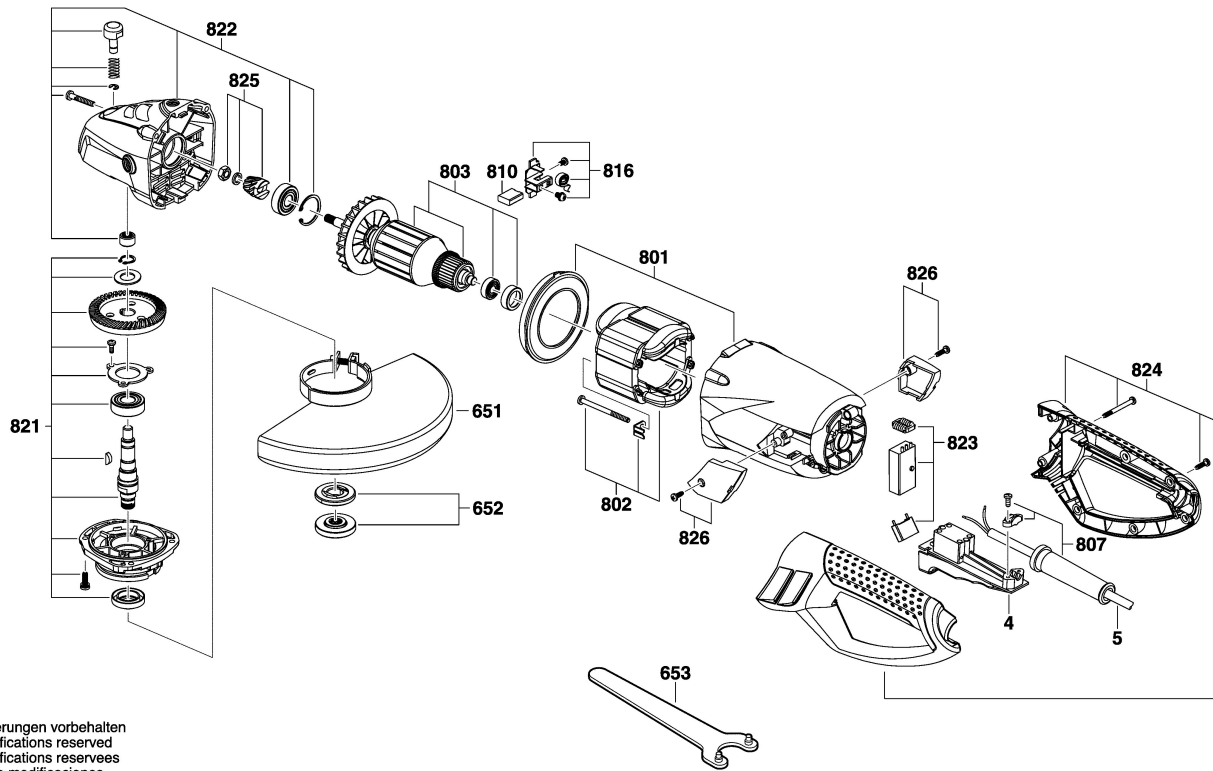

Änderungen vorbehalten  
Modifications reserved  
Modificaciones reservadas  
Salvo modificaciones