

F 015 108 201
Stand | 14-01-15
Issue | 14-04-07

Fig. /Abb. 1

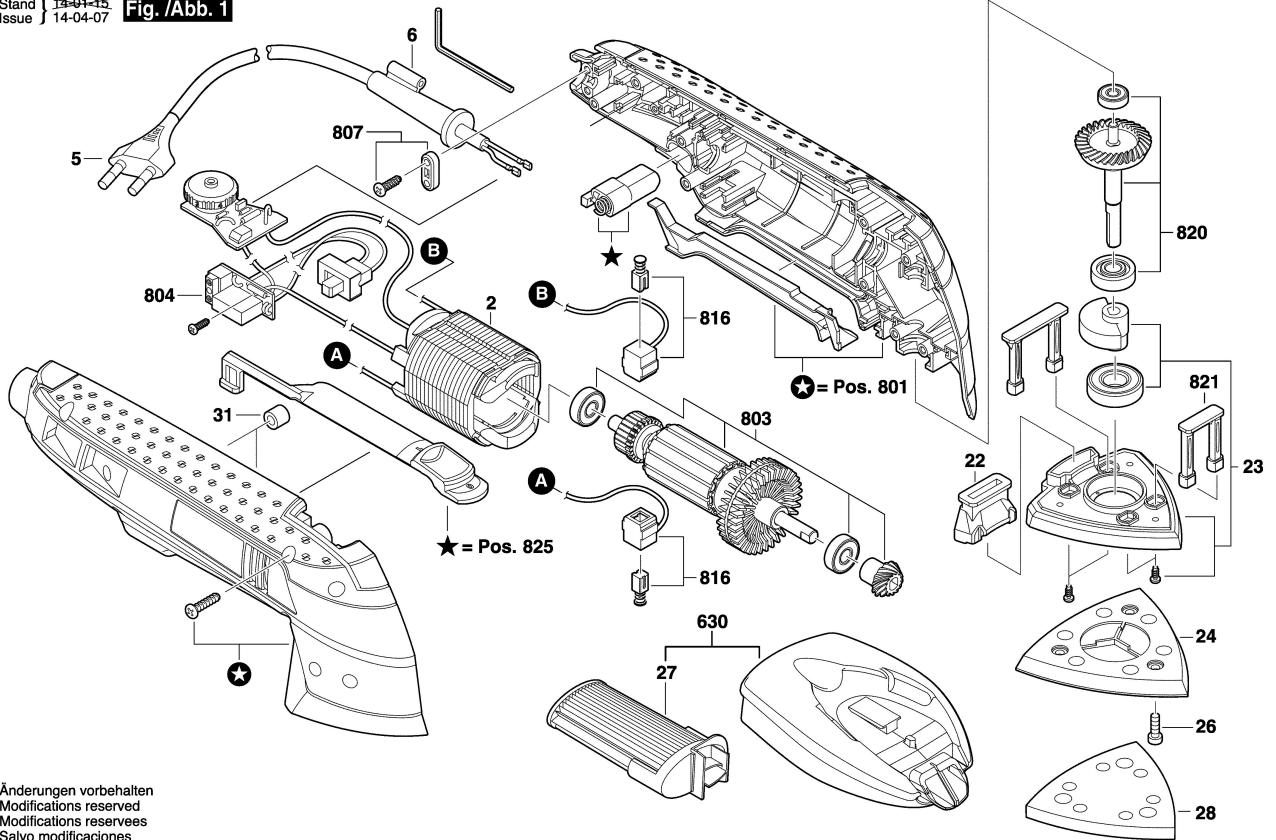

Änderungen vorbehalten
Modifications reserved
Modifications reserves
Salvo modificaciones