

F 015 121 001

Stand } 08-04-22 **Fig./Abb. 1**

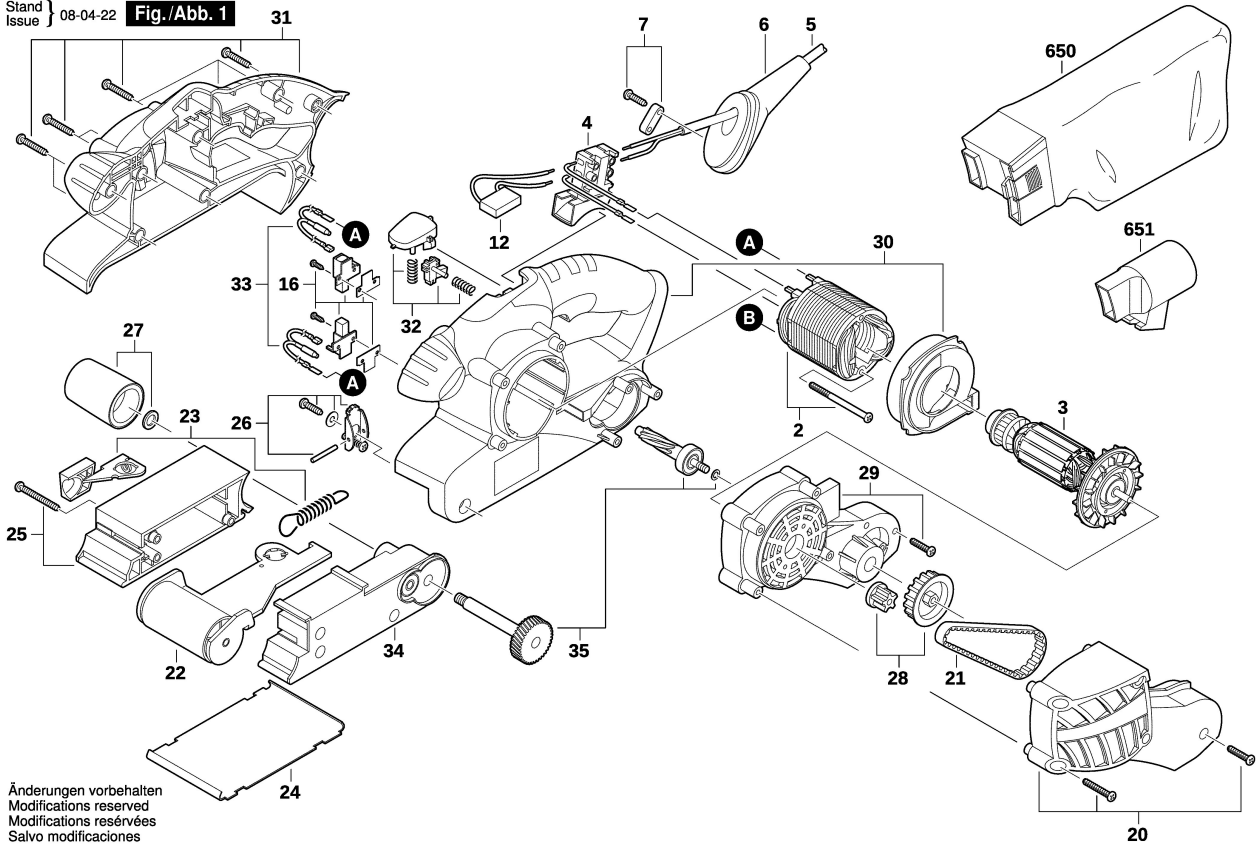

Änderungen vorbehalten
Modifications reserved
Modifications réservées
Salvo modificaciones