

F 015 160 622

Stand } 12-02-07
Issue } 12-02-29

Fig./Abb. 1

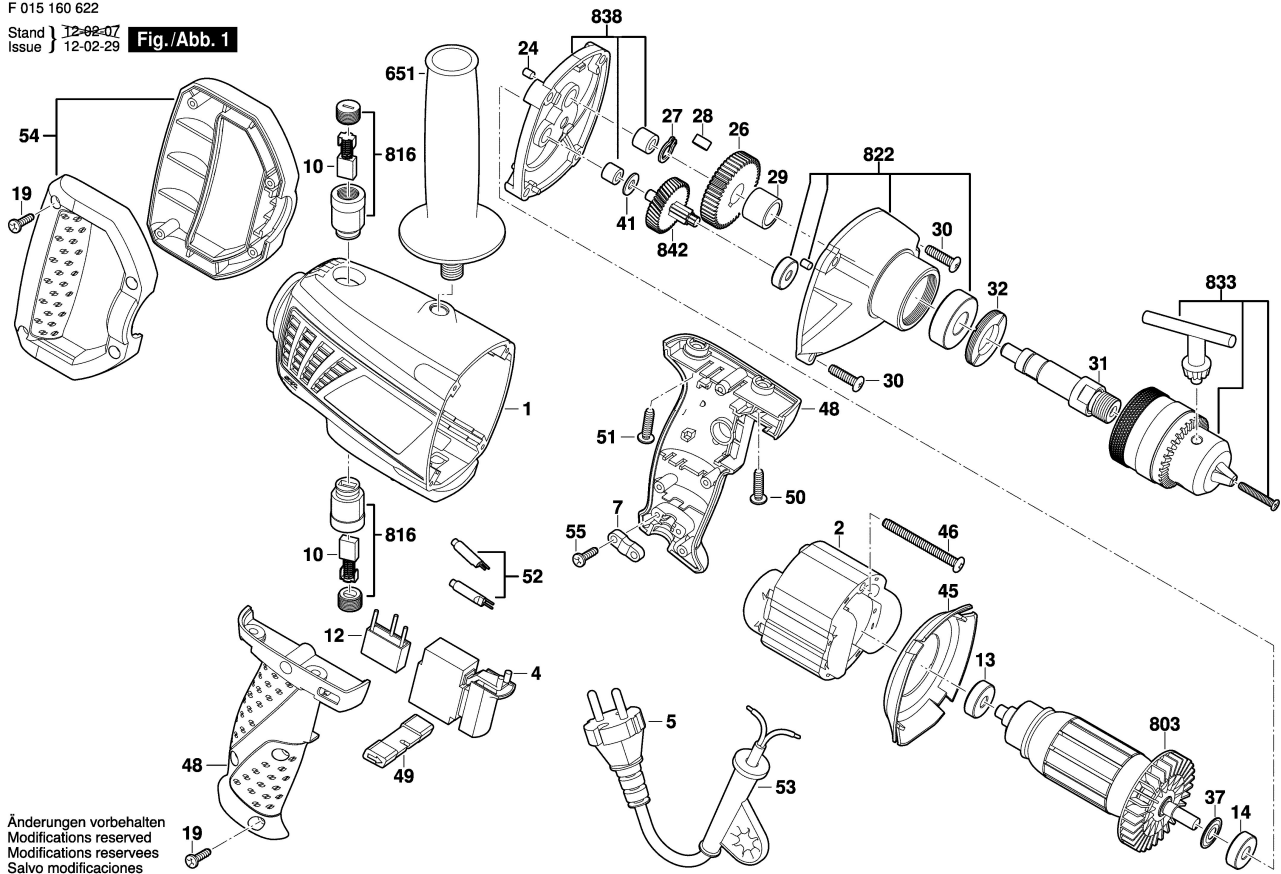

Änderungen vorbehalten
Modifications reserved
Modifications reserves
Salvo modificaciones