

F 015 174 001
Stand 05-06-20
Issue 05-06-22

Fig./Abb. 1

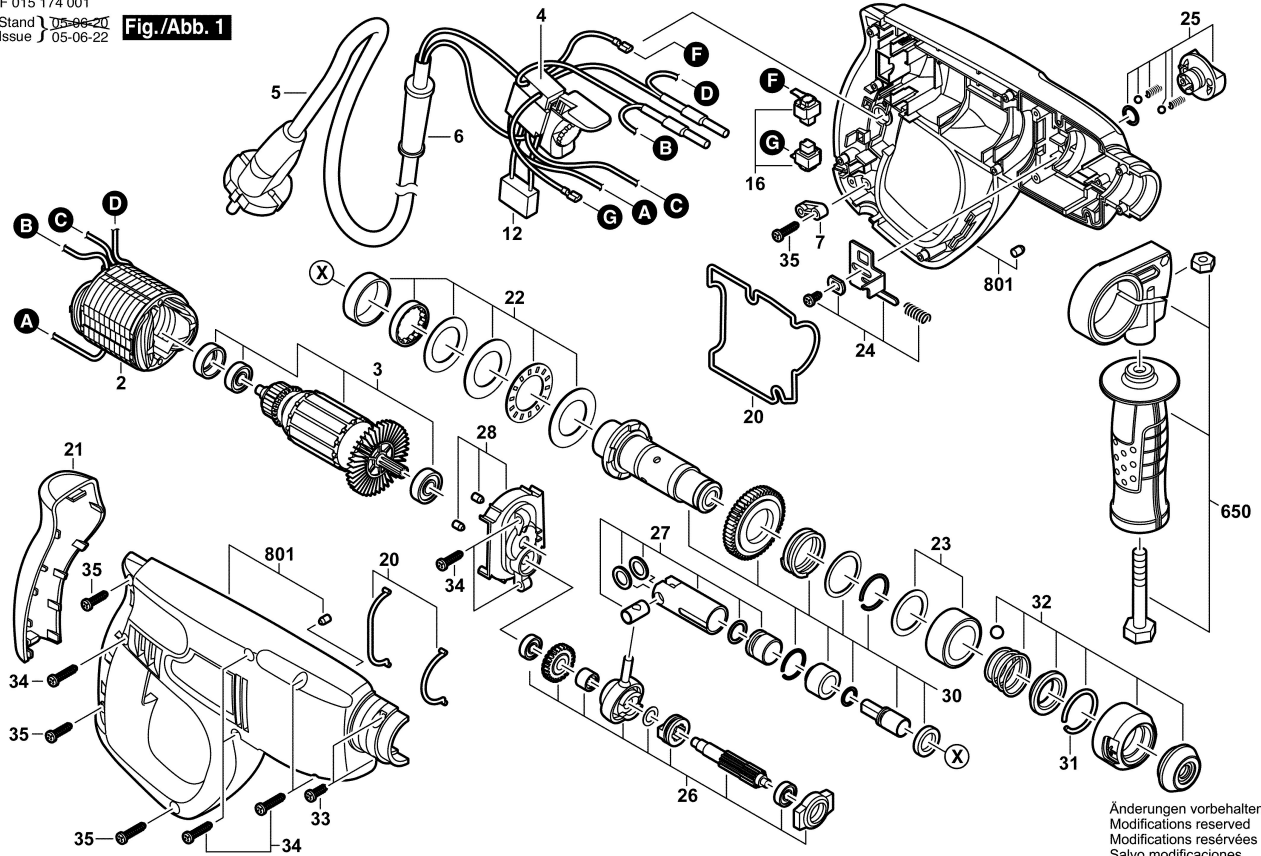

Änderungen vorbehalten
Modifications reserved
Modifications réservées
Salvo modificaciones