

F 015 176 001

Stand | 03-12
Issue | 05-02-10

Fig./Abb. 1

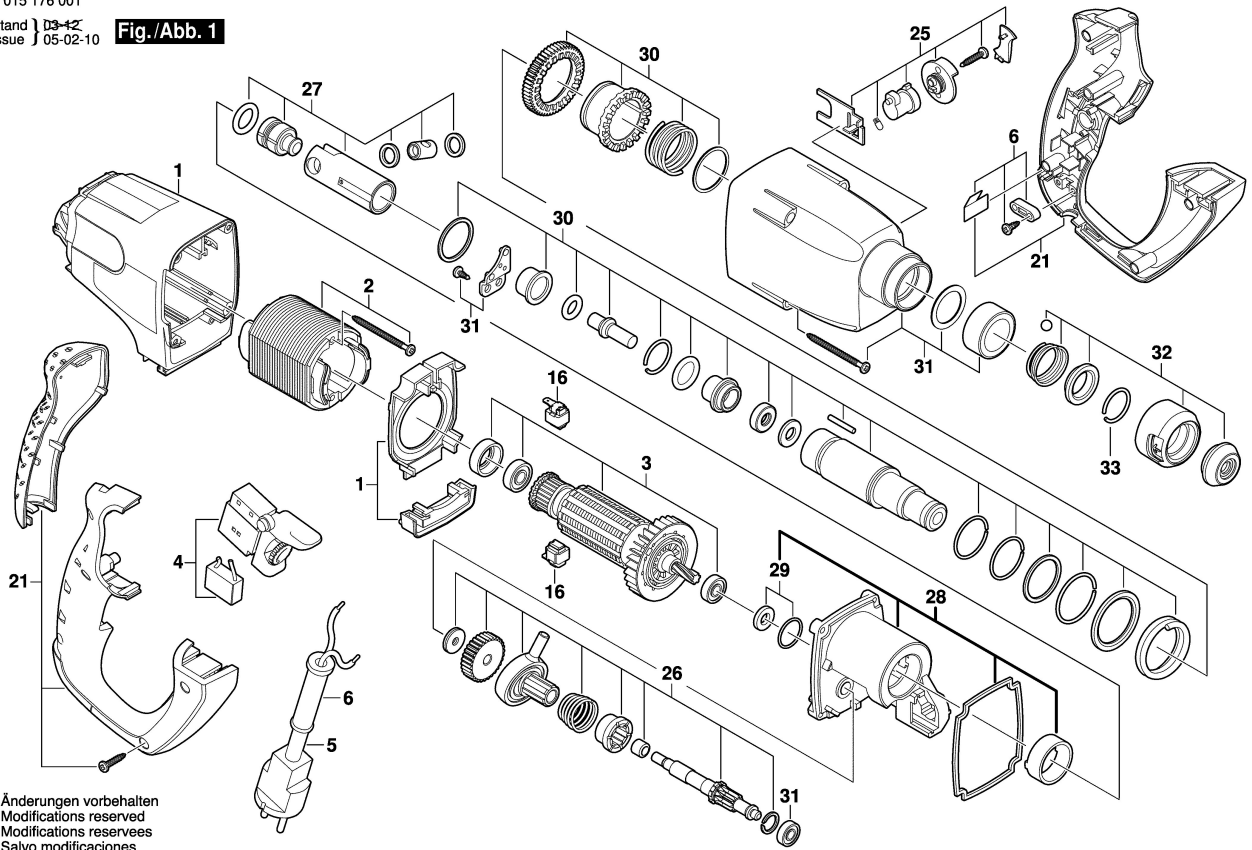

Änderungen vorbehalten
Modifications reserved
Modifications reserves
Salvo modificaciones