

F 015 176 001

Stand | 03-12  
Issue | 05-02-10

**Fig./Abb. 1**

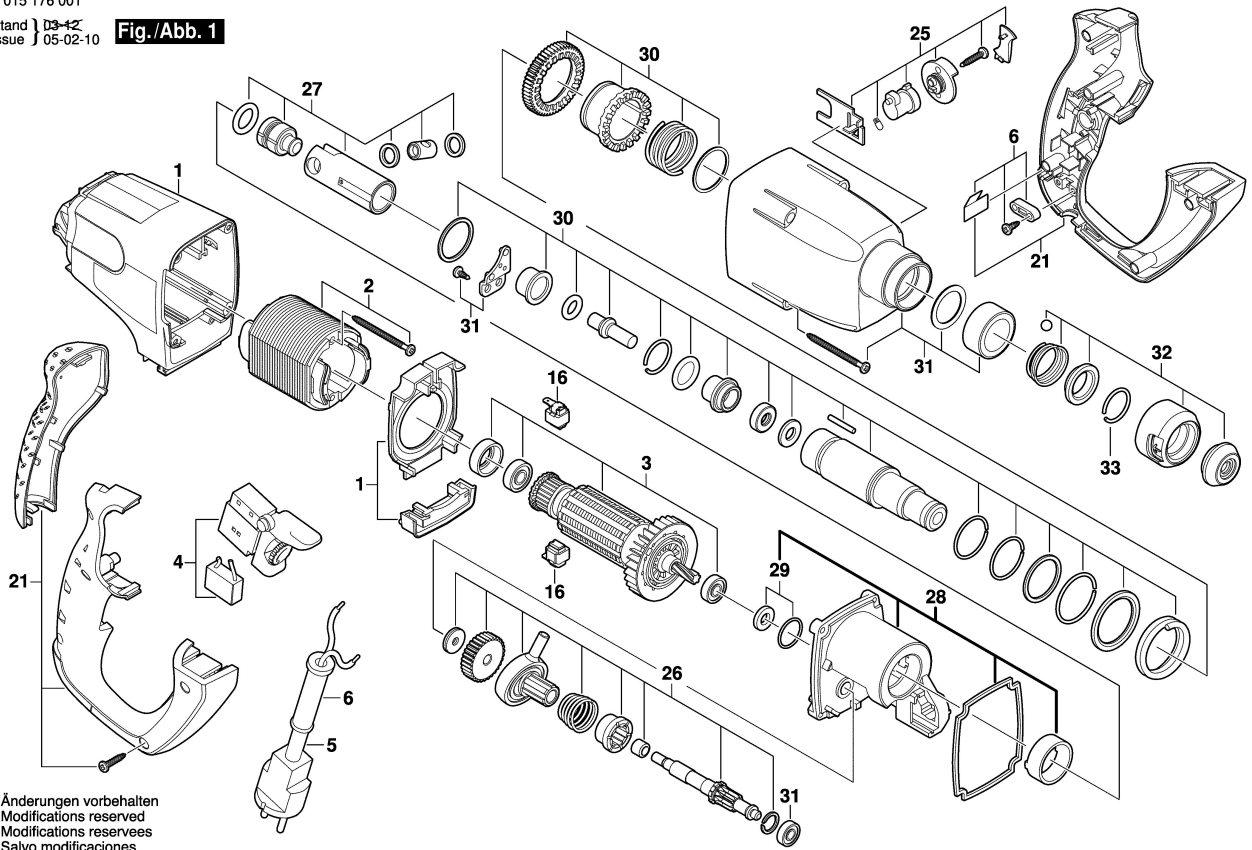

Änderungen vorbehalten  
Modifications reserved  
Modifications reserves  
Salvo modificaciones