

F 015 184 501

Stand } 03-04-01
Issue }

Fig./Abb. 1

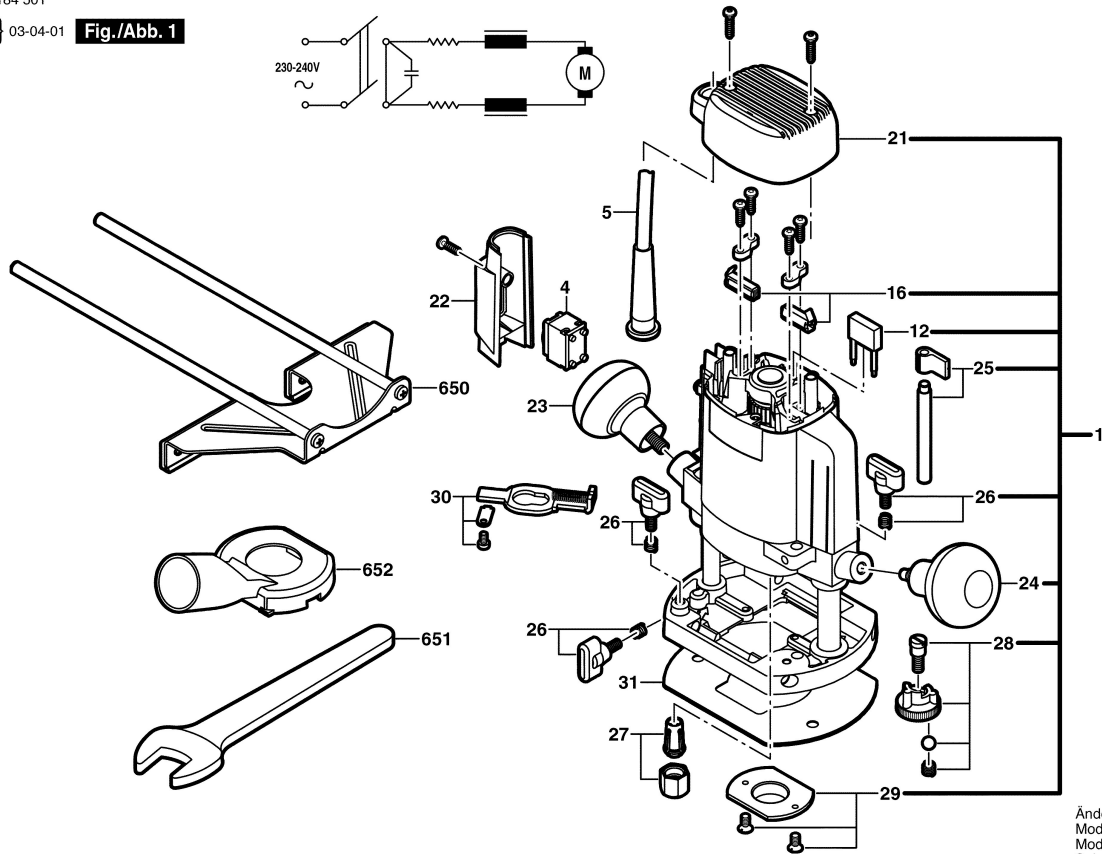

Änderungen vorbehalten
Modifications reserved
Modificacions reserves
Salvo modificaciones