

F 015 200 501

Stand } 07-10-04  
Issue }

**Fig./Abb. 1**

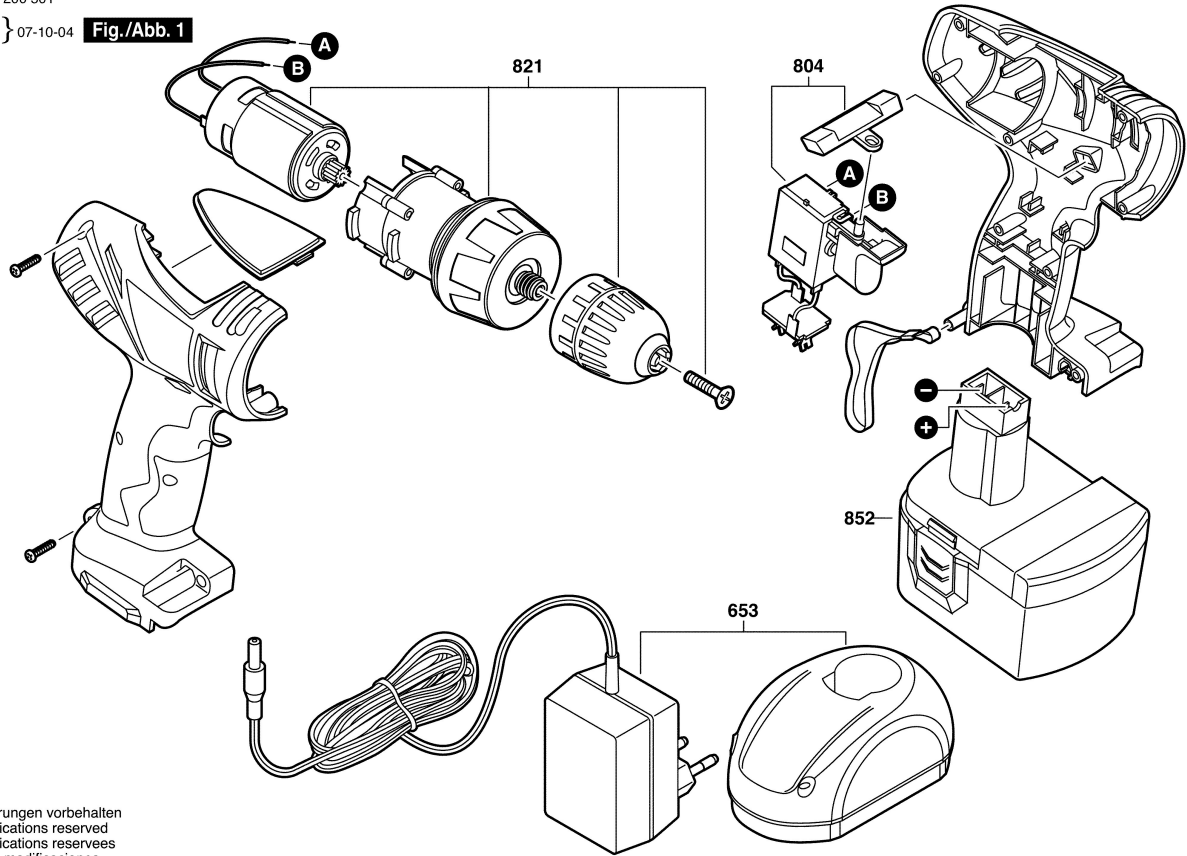

Änderungen vorbehalten  
Modifications reserved  
Modificaciones reserves  
Salvo modificaciones