

F 015 202 601

Stand } 08-01-30  
Issue }

**Fig./Abb. 1**

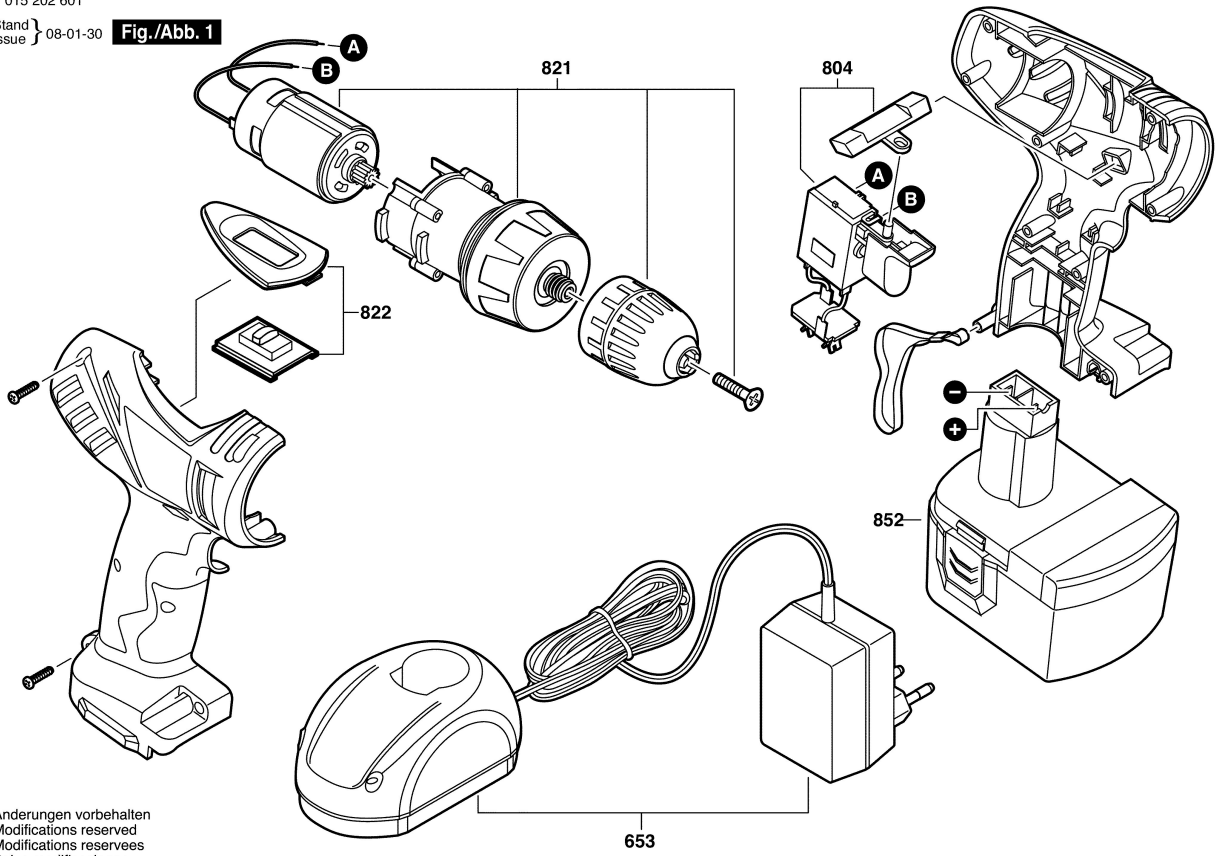

Änderungen vorbehalten  
Modifications reserved  
Modificaciones reservadas  
Salvo modificaciones