

F 015 205 001
Stand 1 06-02
Issue J 07-09-26

Fig./Abb. 1

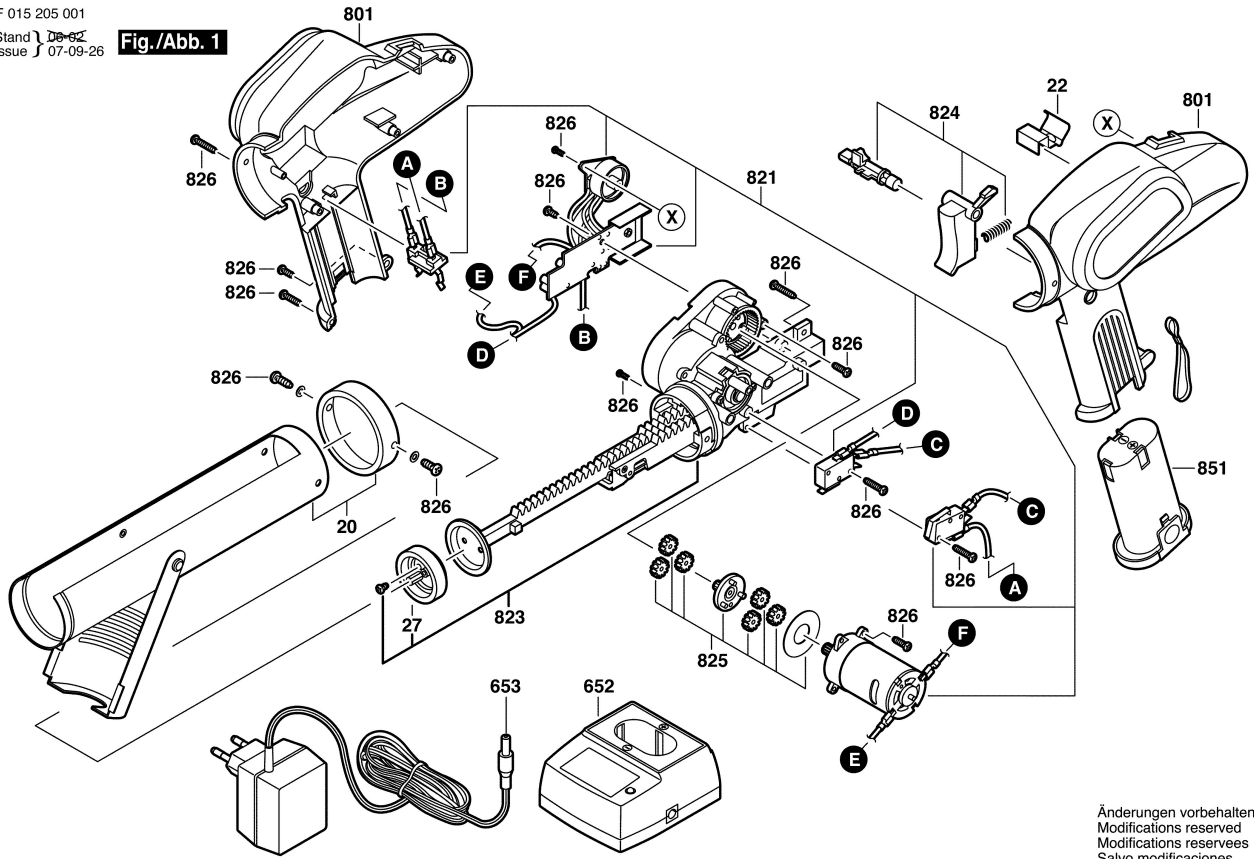

Änderungen vorbehalten
Modifications reserved
Modifications reserves
Salvo modificaciones