

WARNING! Electrical repairs should be attempted only by trained repairmen. Contact the nearest SKIL Service Center or other competent repair service.

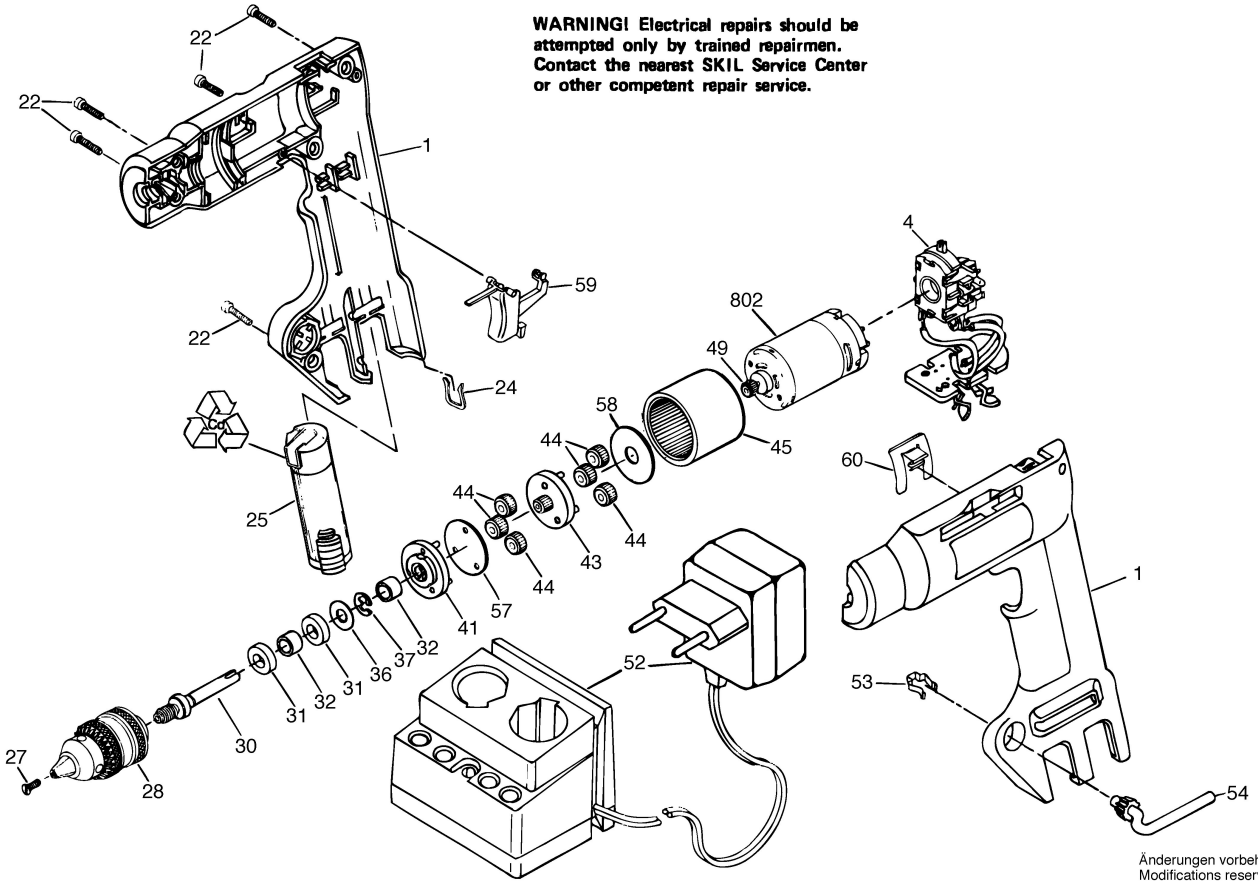

F0152172A11

Änderungen vorbehalten
Modifications reserved
Modifications reserves
Salvo modificaciones