

F 015 221 221
Stand } 1-05
Issue } 12-10-24

Fig./Abb. 1

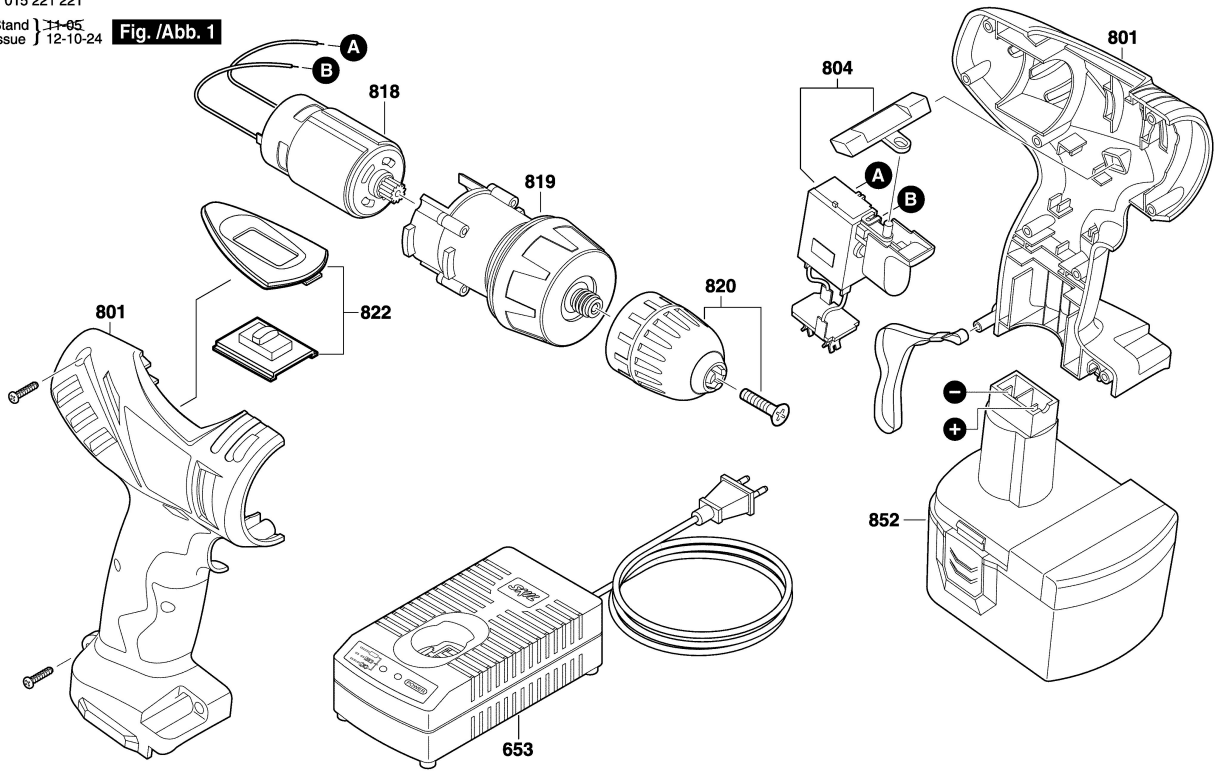

Änderungen vorbehalten
Modifications reserved
Modificaciones reservadas
Salvo modificaciones